



GAIA

parquet master



La vera anima del legno

**GAIA**  
parquet master



## BGP: UN MARCHIO, UNA CERTEZZA BGP: A TRADEMARK, A CERTAINTY

La BGP Trading nasce vent'anni fa, grazie all'esperienza trentennale dei suoi fondatori. Si tratta di una realtà estremamente dinamica e in forte espansione, che domina il mercato delle pavimentazioni anche a livello internazionale. L'azienda vanta una conduzione familiare e si distinguono per la capacità di copertura di categorie prodotti diverse, tra cui GAIA, che operano in assoluta sinergia, mosse da una passione autentica, all'interno di un settore in continua evoluzione. La nostra esperienza ci ha reso profondi conoscitori del mondo del legno, ma siamo costantemente alla ricerca delle novità più all'avanguardia, per fornire ai nostri clienti i materiali più innovativi e moderni, sempre lavorati secondo lo stile italiano.

BGP Trading was born twenty years ago, thanks to the thirty years of experience of its founder. The company is extremely dynamic, continually expanding, dominating the flooring market also internationally. The company has the advantage of being family run and they stand out for their capacity to cover different product categories, among which GAIA, and they operate in absolute synergy, moved by an authentic passion, within a sector in continuous evolution. Our experience has made us true connoisseurs in the world of wood, but we are constantly on the look-out for more cutting-edge innovations, to supply our clients with more innovative and modern materials, always fashioned according to the Italian style.



## QUALITÀ E PASSIONE: IL BINOMIO DEL SUCCESSO

*QUALITY AND PASSION: THE COMBINATION FOR SUCCESS*

Il legno è parte integrante della nostra quotidianità e crediamo fermamente che la cura per i dettagli sia indispensabile per raggiungere i nostri obiettivi. Utilizziamo unicamente prodotti certificati e di indiscutibile valore, a partire dai fornitori e le materie prime, che scegliamo con estrema attenzione. La massima qualità dei prodotti riflette la nostra filosofia aziendale, perché la soddisfazione del cliente è sempre di primaria importanza per noi. Un team di esperti è pronto a guidarti nella scelta dei colori e dei materiali più adatti per la tua abitazione, consigliandoti le soluzioni più innovative, all'interno di un catalogo ben assortito e creato con profondo amore per questo lavoro.

Wood is the integral part of our everyday life and we strongly believe that attention to detail is indispensable to reach our objectives. We only use certified products and of indisputable value, starting from the suppliers and the raw materials, which we chose with extreme attention. The highest quality of the products reflects our company philosophy, because the satisfaction of our clients is always of primary importance to us. A team of experts is ready to guide you in the choice of colours and in the materials most suitable for your home, advising you on the most innovative solutions, inside a well-stocked catalogue created with a deep love for this work.



## IL CLIENTE AL CENTRO THE CLIENT AT THE CENTRE

La nostra missione è adempiere alle richieste del cliente con la massima serietà ed efficienza. Flessibilità e velocità di realizzazione sono concetti imprescindibili del nostro lavoro e disponiamo di enormi quantità di materiali in pronta consegna, che ci permettono di evadere ordini in modo rapido e preciso. Tutti i nostri prodotti si caratterizzano per un ottimo rapporto qualità-prezzo e le possibilità di scelta sono sconfinite. Le diverse collezioni sono state pensate per abbracciare le esigenze di ogni singolo cliente e la nostra sfida è quella di garantire sempre il massimo livello di soddisfazione e personalizzazione. Per questo offriamo una customer experience a 360°, assistendo il cliente in ogni fase del processo.

Our mission is to fulfill the requests of our client with maximum reliability and efficiency. Flexibility and speed in this accomplishment are essential concepts of our work and we have an enormous quantity of material available, which allows us to fulfill orders rapidly and precisely. All our products are characterized by an excellent value for money and the possibilities of choice are unlimited. The different collections have been developed to embrace the requirements of every single client and the challenge for us is to always guarantee the maximum level of satisfaction and personalization. Thus, we offer a customer an all-round service, assisting the client in each phase of the process.



**Il marchio della  
gestione forestale  
responsabile**



## LA NOSTRA SCELTA ETICA OUR ETHIC CHOICE

La BGP crede nel rispetto dell'uomo e dell'ambiente, per questo offriamo prodotti che dispongono di certificazioni eticamente responsabili, riconosciute nel panorama internazionale. I marchi FSC (Forest Stewardship Council) e PEFC (Programme for Endorsement of Forest Certification Schemes) garantiscono che tutte le fasi di lavorazione del legno rispondono ad elevati standard di salvaguardia ambientale, permettendo al consumatore di acquistare prodotti dichiaratamente ecologici. L'obiettivo è quello di implementare una gestione forestale sostenibile, sia dal punto di vista ambientale, che socio-economico. Si tratta di un progetto di vitale importanza, a cui abbiamo aderito scegliendo di proteggere e valorizzare la natura, diventando attori responsabili, che si prendono cura del pianeta in cui tutti viviamo.

BGP believes in respect for man and the environment, thus we offer products that have ethically responsible certificates recognized in the international panorama. The stamps FSC (Forest Stewardship Council) and PEFC (Programme for Endorsement of Forest Certification Schemes) guarantee that all the phases of work with wood respond to high standards of environmental protection, allowing the consumer to acquire products declared ecological. The objective is to implement a sustainable forest management, both from the point of view of the environment and socio-economic. It is a project of vital importance, to which we have adhered, choosing to protect and value nature, becoming responsible participators, who take care of the planet in which we all live.



# ESSENZE

WOOD  
SPECIES



ROVERE EUROPEO

14



ROVERE RUSSO



NOCCE NAZIONALE



NOCCE AMERICANO

15



TEAK ASIA



IROKO



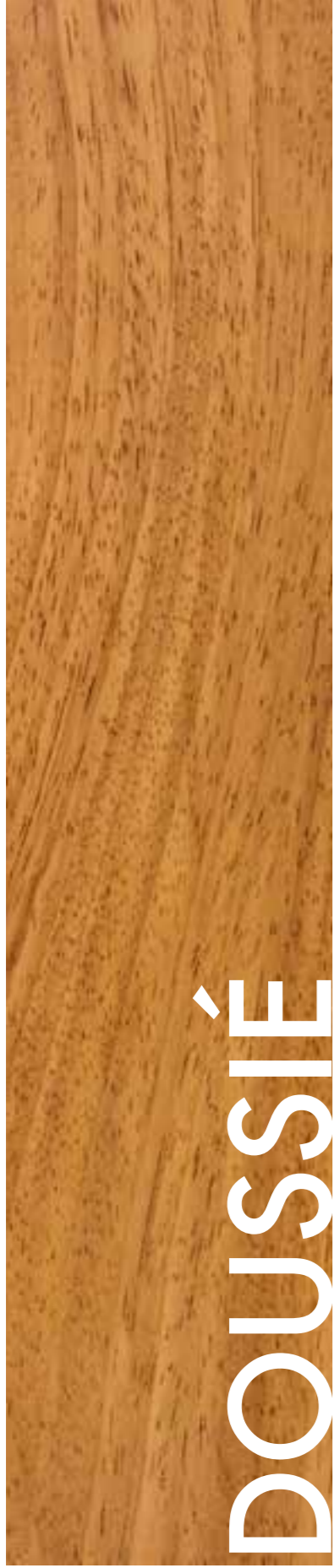

DOUSSIÉ



LARICE



BAMBOO





PAVIMENTI IN ROVERE 10 MM  
OAK WOODEN FLOORING 10 MM



PAVIMENTI IN ROVERE 14/15 MM  
OAK WOODEN FLOORING 14/15 MM



VARIE ESSENZE  
VARIOUS SPECIES



COLLEZIONE WPC  
WPC COLLECTION



ACCESSORI  
ACCESSORIES

## PAVIMENTI IN ROVERE 10 MM

### OAK WOODEN FLOORING 10 MM

ROVERE 10 MM	Pag. 25
1090EXTRA	Pag. 31
VESUVIO	Pag. 37
10190	Pag. 43
ESSENCE	Pag. 49
CITY	Pag. 57

## PAVIMENTI IN ROVERE 14/15 MM

### OAK WOODEN FLOORING 14/15 MM

PL142 3 STRIP	Pag. 65
ROVERE 189	Pag. 69
PL143	Pag. 75
PL72	Pag. 81
STONES	Pag. 89
GHOST	Pag. 95
MATERA	Pag. 101
VULCANO	Pag. 107
STATES	Pag. 113
OLIMPIA	Pag. 119
BARRIQUE	Pag. 125
ALPES	Pag. 129
COUNTRY	Pag. 135
FARM	Pag. 141

## VARIE ESSENZE

### VARIOUS SPECIES

WOOD 10 MM	Pag. 151
BAMBOO	Pag. 157
LARICE 190	Pag. 163
TEAK ASIA	Pag. 167
NOCE AMERICANO	Pag. 171

## WPC PAVIMENTI PER ESTERNI

### WPC OUTDOOR FLOORING

WPC	Pag. 175
WPC PROTECTA	Pag. 179

## ACCESSORI

### ACCESSORIES

BATTISCOPIA	Pag. 190
TORI	Pag. 194
SOGLIE	Pag. 196
PER LA POSA FLOTTANTE	Pag. 198
PER LA POSA INCOLLATA	Pag. 198
PRODOTTI PER LA MANUTENZIONE	Pag. 199



PAVIMENTI  
IN ROVERE  
10 MM

OAK  
WOODEN FLOORING  
10 MM



COLLEZIONE  
**ROVERE**  
**10 MM**

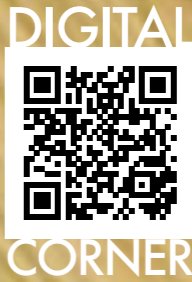



## COLLEZIONE ROVERE 10 mm

Plancetta in essenza di rovere europeo, supportata 2 strati con multistrato di betulla.

2-ply european oak with birch multiply.

**Essenza / Wood specie:**

Rovere europeo / European oak

**Supporto / Back Layer:**

Nobile 4 mm + supporto 6 mm  
4 mm top layer + 6 mm back layer

**Dimensioni / Dimensions:**

10x120x600/1500 mm  
10x90x600/1250 mm

**Struttura / Composition:**

Nobile 4 mm + supporto 6 mm  
4 mm top layer + 6 mm back layer

**Lavorazione / Surface:**

Liscia / Smooth  
Spazzolata / Brushed

**Finitura / Finishing:**

Vernice UV naturale / Natural UV lacquer

**Bisellatura / Bevel:**

Spigolo vivo / Square edge

**Riscaldamento a pavimento / Floor heating:**

Adatto / Suitable

**Classe di reazione al fuoco / Reaction to fire:**

cf1-s1



## Rovere 10 mm - ROVERE 1090 AB



Tipo di posa / Installation:

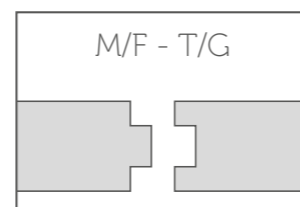

INCOLLATA / GLUED

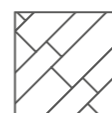

Posabile in 2 larghezze  
Installable in 2 widths

A sinistra / On the left:  
Rovere 10 mm - ROVERE 1090 AB

Descrizione / Description	Scelta / Grade	Uni / Uni	Dimensioni / Dimensions	Codice / Code	Listino-mq / Price list-m <sup>2</sup>
ROVERE - Verniciato liscio Oak lacquered smooth	AB	○	10/4x90x600/1250 mm	1090R001	€ 72,84
ROVERE - Verniciato liscio Oak lacquered smooth	C	△	10/4x90x600/1250 mm	1090R002	€ 66,67
ROVERE - Verniciato liscio Oak lacquered smooth	AB	○	10/4x120x600/1500 mm	10120R001	€ 83,96
ROVERE - Verniciato liscio Oak lacquered	C	△	10/4x120x600/1500 mm	10120R002	€ 79,02
ROVERE - Spazz. verniciato Oak brushed and lacquered	AB	○	10/4x120x600/1500 mm	10120R003	€ 88,90
ROVERE - Spazz. verniciato Oak brushed and lacquered	C	△	10/4x120x600/1500 mm	10120R004	€ 83,96
Battiscopa imp.to rovere verniciato naturale 80x10 mm / Oak veneered skirting natural lacquered 80x10 mm					€ / ml 4,70
Accessori disponibili a pag. 189 / Accessories available at page 189					



COLLEZIONE  
**1090**  
**EXTRA**







NATURALE

32



ICELAND



NATURALIZZATO



QUERCIA ANTICA



ARTIC

33



WENGÉ

## COLLEZIONE 1090 EXTRA

Plancetta in essenza di rovere supportata 2 strati con multistrato di betulla, spazzolato e verniciato.

2-ply oak with birch multiply, brushed and lacquered.

**Essenza / Wood Specie:**

Rovere / Oak

**Supporto / Back Layer:**

Nobile 4 mm + Supporto 6 mm  
4 mm top layer + 6 mm back layer

**Dimensioni / Dimensions:**

10x90x600/1200 mm

**Struttura / Composition:**

Nobile 4 mm + supporto 6 mm  
4 mm top layer + 6 mm back layer

**Lavorazione / Surface:**

Spazzolata / Brushed

**Finitura / Finishing:**

Vernice UV / UV Lacquer

**Bisellatura / Bevel:**

Spigolo vivo / Square edge

**Riscaldamento a pavimento / Floor heating:**

Adatto / Suitable

**Classe di reazione al fuoco / Reaction to fire:**

Cfl-S1



## 1090 extra - ICELAND



Tipo di posa / Installation:

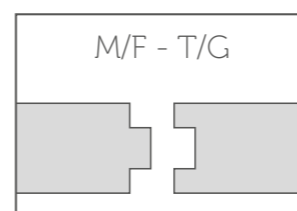

INCOLLATA / GLUED

A sinistra / On the left:  
1090 Extra - NATURALE

Tipologia / Type	Scelta / Grade	Uni / Uni	Dimensioni / Dimensions	Codice / Code	Listino-mq / Price list-m <sup>2</sup>
NATURALE	ABC	△	10/4x90x600/1200 mm	1090EX001	€ 66,67
ICELAND	ABC	△	10/4x90x600/1200 mm	1090EX009	€ 69,14
NATURALIZZATO	ABC	△	10/4x90x600/1200 mm	1090EX010	€ 69,14
QUERCIA ANTICA	ABC	△	10/4x90x600/1200 mm	1090EX004	€ 69,14
ARTIC	ABC	△	10/4x90x600/1200 mm	1090EX011	€ 69,14
WENGÈ	ABC	△	10/4x90x600/1200 mm	1090EX006	€ 69,14
Battiscopa BC imp.to rovere verniciato in abbinamento 80x13 mm / Oak veneered skirting color matching 80x13 mm					€ / ml 9,40
Battiscopa BC imp.to rovere verniciato naturale 80x10 mm / Oak veneered skirting natural 80x10 mm					€ / ml 4,70
Accessori disponibili a pag. 189 / Accessories available at page 189					



COLLEZIONE  
**VESUVIO**



A vertical wooden plank with a light brown, slightly uneven grain. A prominent vertical crack runs down the center, with some blueish staining around it.

AMALFI

38

A vertical wooden plank with a light brown, wavy grain pattern and several small dark knots.

BELVEDERE

A vertical wooden plank with a dark brown, wavy grain pattern and several dark knots.

CAPRI

A vertical wooden plank with a light brown, wavy grain pattern and several small dark knots.

DRAGONI

39

A vertical wooden plank with a light brown, wavy grain pattern and several small dark knots.

ERCOLANO

## COLLEZIONE VESUVIO

Plancetta in essenza di rovere francese, supportata 2 strati, scelta rusticone.

2-ply french oak, rustic grading.

**Essenza / Wood Specie:**

Rovere francese / French Oak

**Supporto / Back Layer:**

Multistrato / Multiply

**Dimensioni / Dimensions:**

10x158x1220 mm

**Struttura / Composition:**

Nobile 2,5 mm + supporto 7,5 mm

2,5 mm top layer + 7,5 mm back layer

**Lavorazione / Working:**

> Amalfi, Belvedere, Capri:

Smoked forte, piallato, spazzolato

Heavy smoked, hand scraped and brushed

> Dragoni, Ercolano:

Spazzolato / Brushed

**Finitura / Finishing:**

> Amalfi, Belvedere, Capri:

Olio naturale / Natural oil

> Dragoni, Ercolano:

Olio Uv / UV oil

**Bisellatura / Bevel:**

Micro - bisellato / Micro - beveled

**Confezione / Packaging:**

1,735 m<sup>2</sup>

**Riscaldamento a pavimento / Floor heating:**

Adatto / Suitable



## Vesuvio - AMALFI

Tipo di posa / Installation:

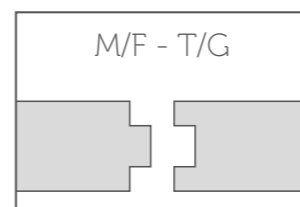

INCOLLATA / GLUED

Colore / Colour	Scelta / Grade	Uni / Uni	Dimensioni / Dimensions	Codice / Code	Listino-mq / Price list-m <sup>2</sup>
AMALFI	CDE	<input type="checkbox"/>	10/2,5x158x1220 mm	PL158A	€ 64,20
BELVEDERE	CDE	<input type="checkbox"/>	10/2,5x158x1220 mm	PL158B	€ 64,20
CAPRI	CDE	<input type="checkbox"/>	10/2,5x158x1220 mm	PL158C	€ 64,20
DRAGONI	CDE	<input type="checkbox"/>	10/2,5x158x1220 mm	PL158D	€ 60,50
ERCOLANO	CDE	<input type="checkbox"/>	10/2,5x158x1220 mm	PL158E	€ 60,50
Battiscopa imp.to rovere oliato in abbinamento 80x13 mm / Oak veneered skirting color matching 80x13 mm					€ / ml 13,60
Accessori disponibili a pag. 189 / Accessories available at page 189					

A sinistra / On the left:  
Vesuvio - ERCOLANO

COLLEZIONE  
**FIORDO**  
**10190**





DE



EF



Fiordo 10190 - EF

## COLLEZIONE FIORDO/10190

Plancetta in Rovere Francese, supportata 2 strati, spessore 10 mm, scelta rusticone extra.

2-ply French oak, 10 mm thickness, extra rustic grading

**Essenza / Wood specie:**

Rovere francese / French oak

**Supporto / Back Layer:**

Multistrato / Multiply

**Dimensioni / Dimensions:**

10x190x1900 mm

**Struttura / Composition:**

Nobile 3 mm + supporto 7 mm

3 mm top layer + 7 mm back layer

**Lavorazione / Surface:**

Spazzolata / Brushed

**Finitura / Finishing:**

Vernice UV / UV lacquer

**Bisellatura / Bevel:**

Micro bisello / Micro beveled

**Riscaldamento a pavimento / Floor heating:**

Adatto / Suitable

**Confezione / Packaging:**

3,971 m<sup>2</sup>/pc



# 10190 - DE

Tipo di posa / Installation:

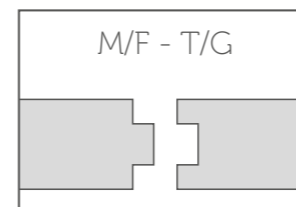

INCOLLATA / GLUED

Tipologia / Type	Scelta / Grade	Uni / Uni	Dimensioni / Dimensions	Codice / Code	Listino-mq / Price list-m <sup>2</sup>
NATURALE	EF	☐	10x190x1900 mm	10190C	€ 66,67
NATURALE	DE	☐	10x190x1900 mm	10190B	€ 69,14
Battiscopa BC imp.to rovere verniciato naturale 80x13 mm / Oak veneered skirting natural 80x13 mm					€ / ml 5,44
Accessori disponibili a pag. 189 / Accessories available at page 189					

A sinistra / On the left:  
10190 Naturale DE





COLLEZIONE  
**ESSENCE**





NATURALE

50



NATURALIZZATO



LIGHT WHITE



NOCCIOLA DECAPÉ

51



RHUM

BALTICO

DARK GREY



Essence - NATURALE

## COLLEZIONE ESSENCE

Plancetta in essenza di rovere, supportata 2 strati, scelta unica, spazzolato e verniciato.

2-ply oak, mixed grading, brushed and lacquered.

**Essenza / Wood Specie:**

Rovere / Oak

**Supporto / Back Layer:**

Multistrato / Multiply

**Dimensioni / Dimensions:**

10x150x1860/1900 mm

**Struttura / Composition:**

Nobile 3 mm + supporto 7 mm

Top layer 3 mm + 7 mm back layer

**Lavorazione / Surface:**

Spazzolata / Brushed

**Finitura / Finishing:**

Vernice UV / UV lacquer

**Bisellatura / Bevel:**

Microbisellata / Micro-Beveled

**Confezione / Packaging:**

2,232 m<sup>2</sup>

**Riscaldamento a pavimento / Floor heating:**

Adatto / Suitable

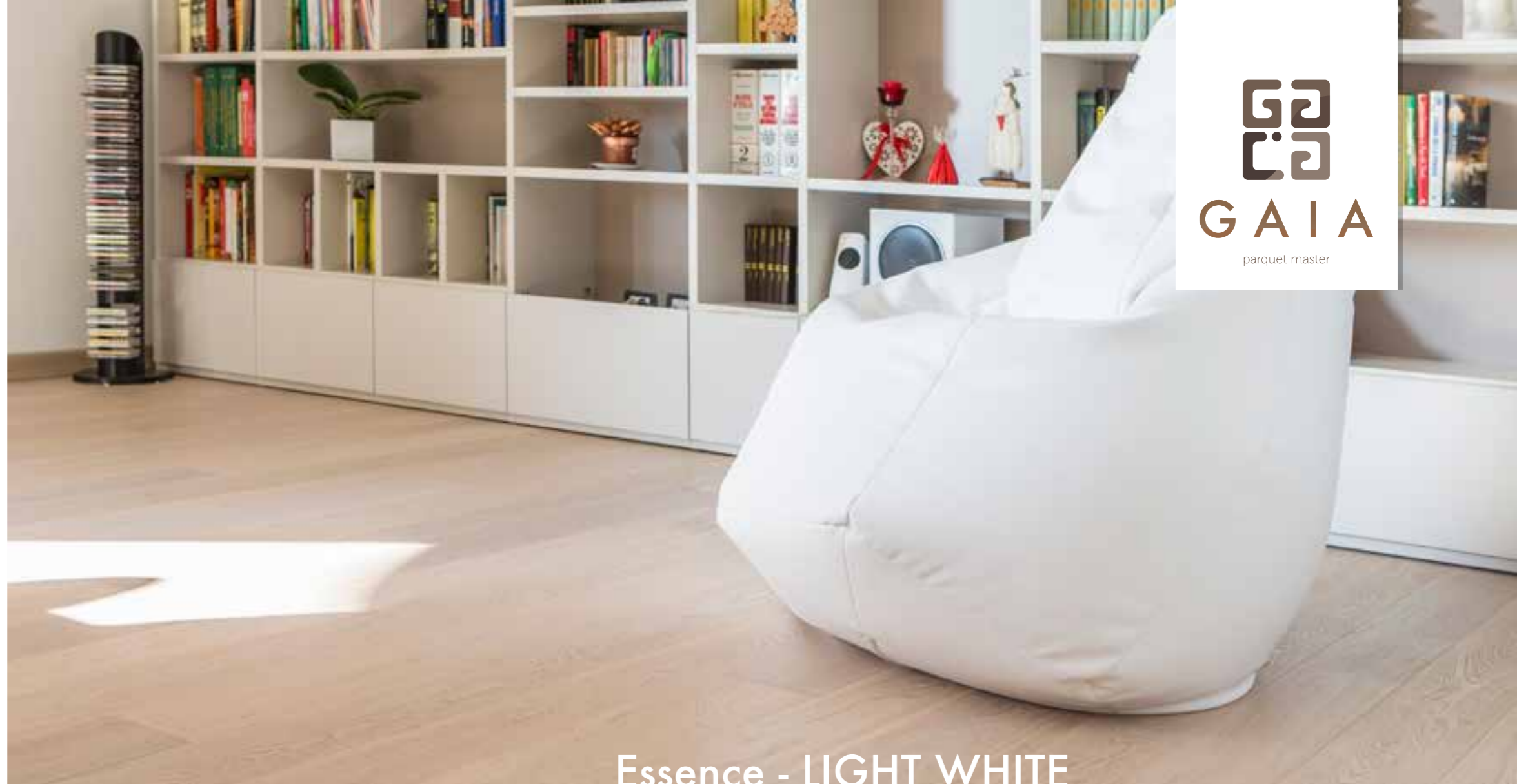

## Essence - LIGHT WHITE



Tipo di posa / Installation:

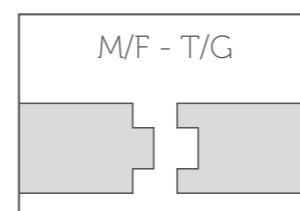

INCOLLATA / GLUED

Colore / Colour	Scelta / Grade	Uni / Uni	Dimensioni / Dimensions	Codice / Code	Listino-mq / Price list-m <sup>2</sup>
NATURALE	ABCD	<input type="checkbox"/>	10/3x150x1860 mm	10150A	€ 71,61
NATURALIZZATO	ABCD	<input type="checkbox"/>	10/3x150x1860 mm	10150B	€ 71,61
LIGHT WHITE	ABCD	<input type="checkbox"/>	10/3x150x1860 mm	10150C	€ 71,61
NOCCIOLA DECAPE'	ABCD	<input type="checkbox"/>	10/3x150x1860 mm	10150D	€ 71,61
RHUM	ABCD	<input type="checkbox"/>	10/3x150x1860 mm	10150E	€ 71,61
BALTICO	ABCD	<input type="checkbox"/>	10/3x150x1860 mm	10150F	€ 71,61
DARK GREY	ABCD	<input type="checkbox"/>	10/3x150x1860 mm	10150G	€ 71,61
Battiscopa imp.to rovere verniciato in abbinamento 80x13 mm / Oak veneered skirting color matching 80x13 mm					€ / ml 9,40
Battiscopa BC imp.to rovere verniciato naturale 80x13 mm / Oak veneered skirting natural 80x13 mm					€ / ml 5,44
Accessori disponibili a pag. 189 / Accessories available at page 189					

A sinistra / On the left:  
Essence - LIGHT WHITE



COLLEZIONE  
**CITY**

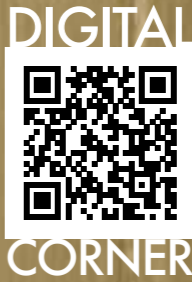



ASPEN



BUFFALO

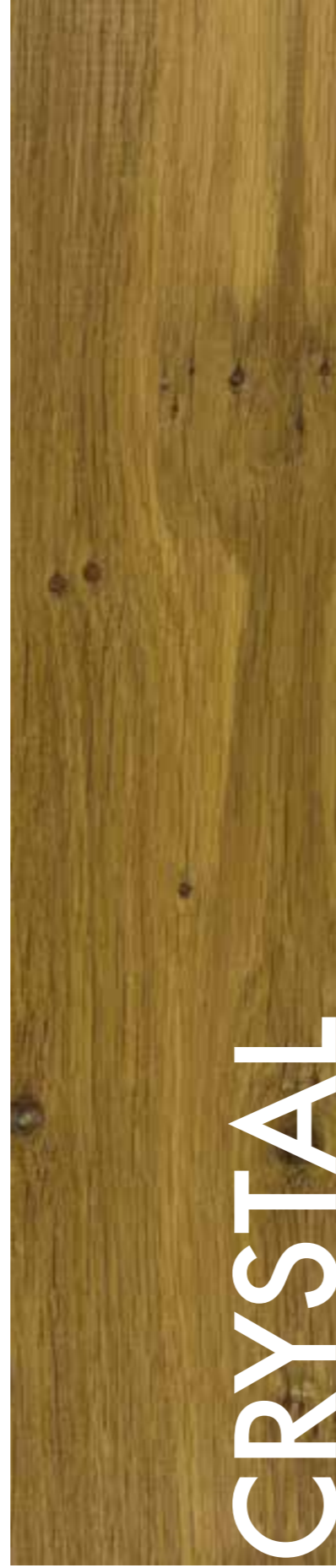

CRYSTAL



City - CRYSTAL

## COLLEZIONE CITY

Plancetta in rovere europeo, supportata 2 strati, spessore 10 mm, scelta rustica con bisello anticato.

Oak 2-ply, 10 mm thickness, rustic grading with antiqued bevel.

**Essenza / Wood Specie:**

Rovere europeo / European oak

**Supporto / Back Layer:**

Multistrato / Multiply

**Dimensioni / Dimensions:**

10x150x1900 mm

**Struttura / Composition:**

Nobile 3 mm + supporto 7 mm

3 mm Top layer+ 7 mm back layer

**Lavorazione / Surface:**

> Aspen, Crystal:

Piallato e spazzolato / Hand scraped and brushed

> Buffalo: Spazzolato / Brushed

**Finitura / Finishing:**

> Aspen: Oliata UV / UV oiled

> Buffalo e Crystal: Oliato naturale / Natural oiled

**Bisellatura / Bevel:**

Bisello Anticato / Antiqued bevel

**Confezione / Packaging:**

2,85 m<sup>2</sup>

**Riscaldamento a pavimento / Floor heating:**

Adatto / Suitable



## City - BUFFALO

Tipo di posa / Installation:

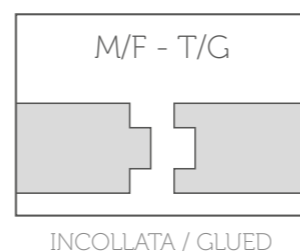

Colore / Colour	Scelta / Grade	Uni / Uni	Dimensioni / Dimensions	Codice / Code	Listino-mq / Price list-m <sup>2</sup>
ASPEN	CDE	<input type="checkbox"/>	10/3x150x1900 mm	PL160A	€ 79,02
BUFFALO	CDE	<input type="checkbox"/>	10/3x150x1900 mm	PL160B	€ 79,02
CRYSTAL	CDE	<input type="checkbox"/>	10/3x150x1900 mm	PL160C	€ 79,02
Battiscopa imp.to rovere oliato in abbinamento 80x13 mm / Oak veneered skirting color matching 80x13 mm					€ / ml 13,60
Accessori disponibili a pag. 189 / Accessories available at page 189					

A sinistra / On the left:  
City - ASPEN



PAVIMENTI  
IN ROVERE  
14/15 MM

OAK  
WOODEN FLOORING  
14/15 MM



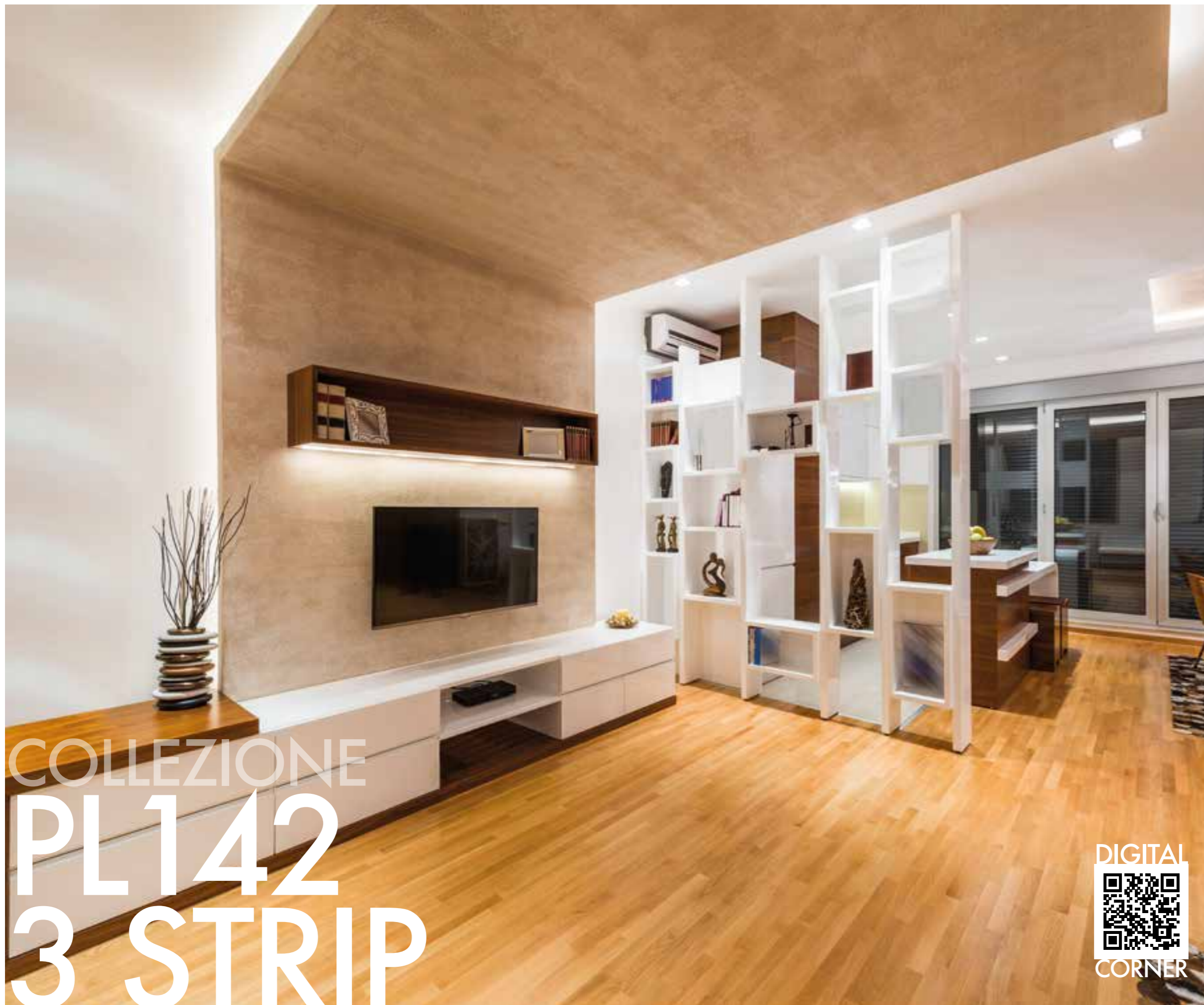

COLLEZIONE  
**PL142**  
**3 STRIP**



## COLLEZIONE PL142 3 STRIP

Plancia 3 strip in essenza di rovere europeo, supportata, 3 strati verniciata, liscia.

3-strip european oak, 3 - ply, smooth finish.

**Essenza / Wood Specie:**

Rovere europeo / European oak

**Supporto / Back Layer:**

Bistrato di abete / Spruce + spruce

**Dimensioni / Dimensions:**

13,5x190x2250 mm

**Struttura / Composition:**

Nobile 3,6 mm + abete 10 mm

Top layer 3,6 mm + spruce 10 mm

**Lavorazione / Surface:**

Liscia / Smooth

**Finitura / Finishing:**

Vernice UV / UV lacquer

**Bisellatura / Bevel:**

Spigolo vivo / Square edge

**Confezione / Packaging:**

2,565 m<sup>2</sup>

**Riscaldamento a pavimento / Floor heating:**

Adatto / Suitable



## PL142 - 3 STRIP

Tipo di posa / Installation:

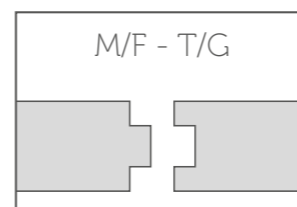

FLOTTANTE / FLOATING  
INCOLLATA / GLUED

Tipologia / Type	Scelta / Grade	Uni / Uni	Dimensioni / Dimensions	Codice / Code	Listino-mq / Price List-M2
ROVERE 3 STRIP - Verniciato	AB	○	13,5/3,5x190x2250 mm	PL142A	€ 59,26
ROVERE 3 STRIP - Verniciato	UNICA	△	13,5/3,5x190x2250 mm	PL142B	€ 46,92
Battiscopa imp.to rovere verniciato liscio 80x13 mm / Oak veneered skirtinglacquered 80x13 mm					€ / ml 5,44
Accessori disponibili a pag. 189 / Accessories available at page 189					

A sinistra / On the left:  
PL142 - 3 STRIP

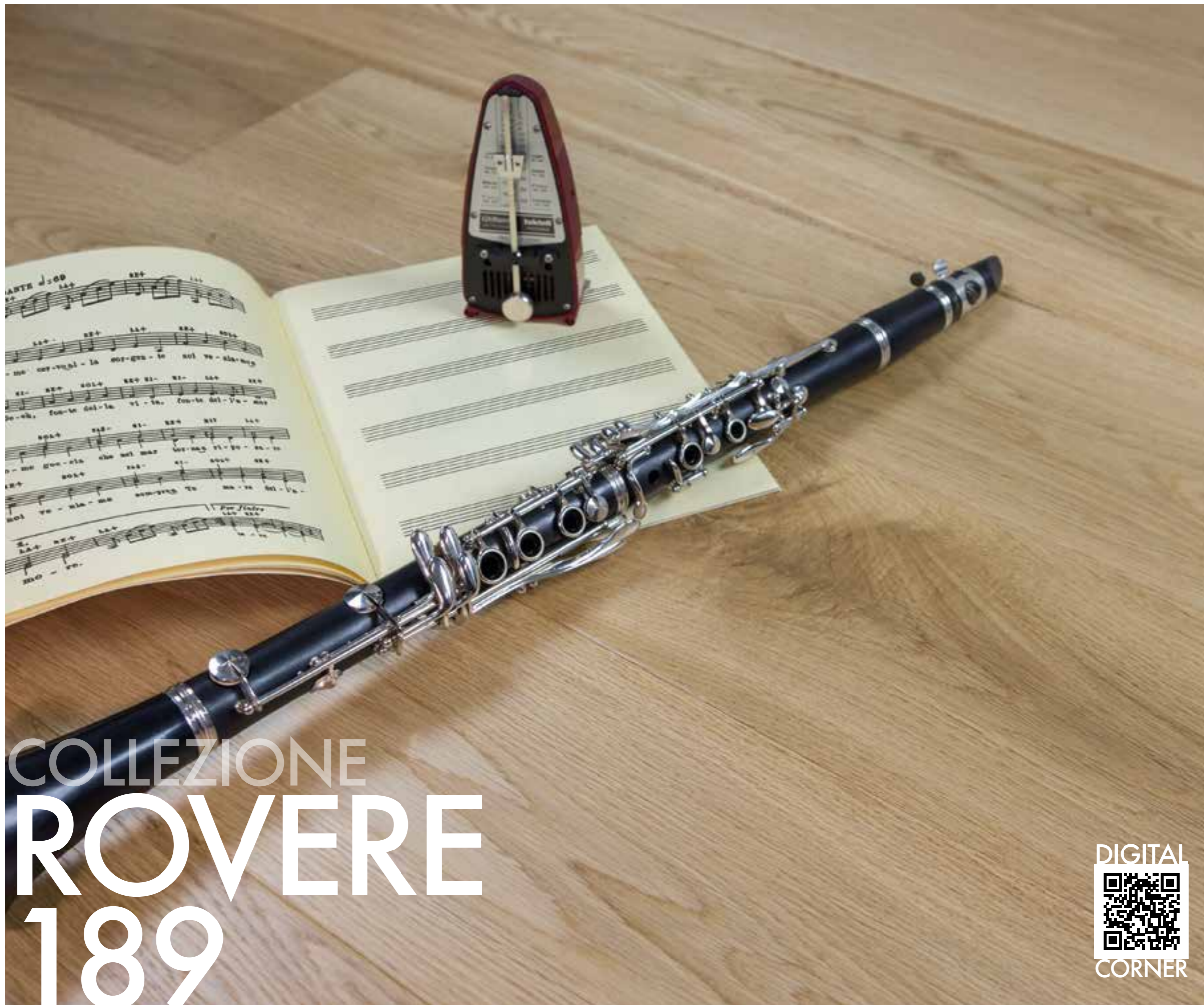

COLLEZIONE  
**ROVERE**  
**189**





## COLLEZIONE ROVERE 189

Plancia unica in essenza di rovere, supportata 3 strati

**Essenza / Wood Specie:**

Rovere / Oak

**Supporto / Back Layer:**

Abete + pioppo / Spruce + poplar

**Dimensioni / Dimensions:**

15/4x148/189x1860 mm

**Struttura / Composition:**

Nobile 4 mm + abete/pioppo 9 mm + pioppo 2 mm

Top layer 4 mm + spruce/poplar 9 mm + poplar 2 mm

**Lavorazione / Surface:**

Vedi tabella / Refer to table

**Finitura / Finish:**

Vedi Tabella / Refer to table

**Bisellatura / Bevel:**

Micro - bisellatura / Micro - beveled

**Riscaldamento a pavimento / Floor heating:**

Adatto / Suitable



## Rovere 189 AB spazzolato verniciato



Tipo di posa / Installation:

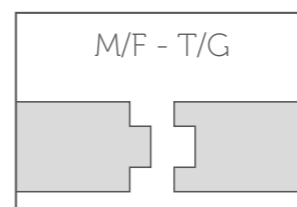

FLOTTANTE / FLOATING  
INCOLLATA / GLUED

Tipologia / Type	Scelta / Grade	Uni / Uni	Dimensioni / Dimensions	Codice / Code	Listino-mq / Price list-m <sup>2</sup>
LISCIO - Verniciato Lacquered	AB	○	15x189/190x1800/1900 mm	PL005	€ 94,82
SPAZZOLATO - Verniciato Brushed and lacquered	AB	○	15x148/150x1800/1900	PL122	€ 92,35
SPAZZOLATO - Verniciato Brushed and lacquered	AB	○	15x189/190x1800/1900 mm	PL001	€ 97,78
SPAZZOLATO - Verniciato Brushed and lacquered	ABC	△	15x148/150x1800/1900	PL122ABC	€ 87,41
SPAZZOLATO - Verniciato Brushed and lacquered	ABC	△	15x189/190x1800/1900 mm	PL118	€ 89,88
SPAZZOLATO - Verniciato Brushed and lacquered	CD	□	15x189/190x1800/1900	PL001A	€ 83,96
PIALLATO - Verniciato Hand scraped and lacquered	CD	□	15x189/190x1800/1900 mm	PL135	€ 93,83
Battiscopa imp.to rovere verniciato in abbinamento 80x13 mm / Oak veneered skirting color matching 80x13 mm					€ / ml 9,40
Battiscopa BC imp.to rovere verniciato naturale 80x13 mm / Oak veneered skirting natural 80x13 mm					€ / ml 5,44
Accessori disponibili a pag. 189 / Accessories available at page 189					

A sinistra / On the left  
ROVERE CD SPAZZOLATO VERNICIATO

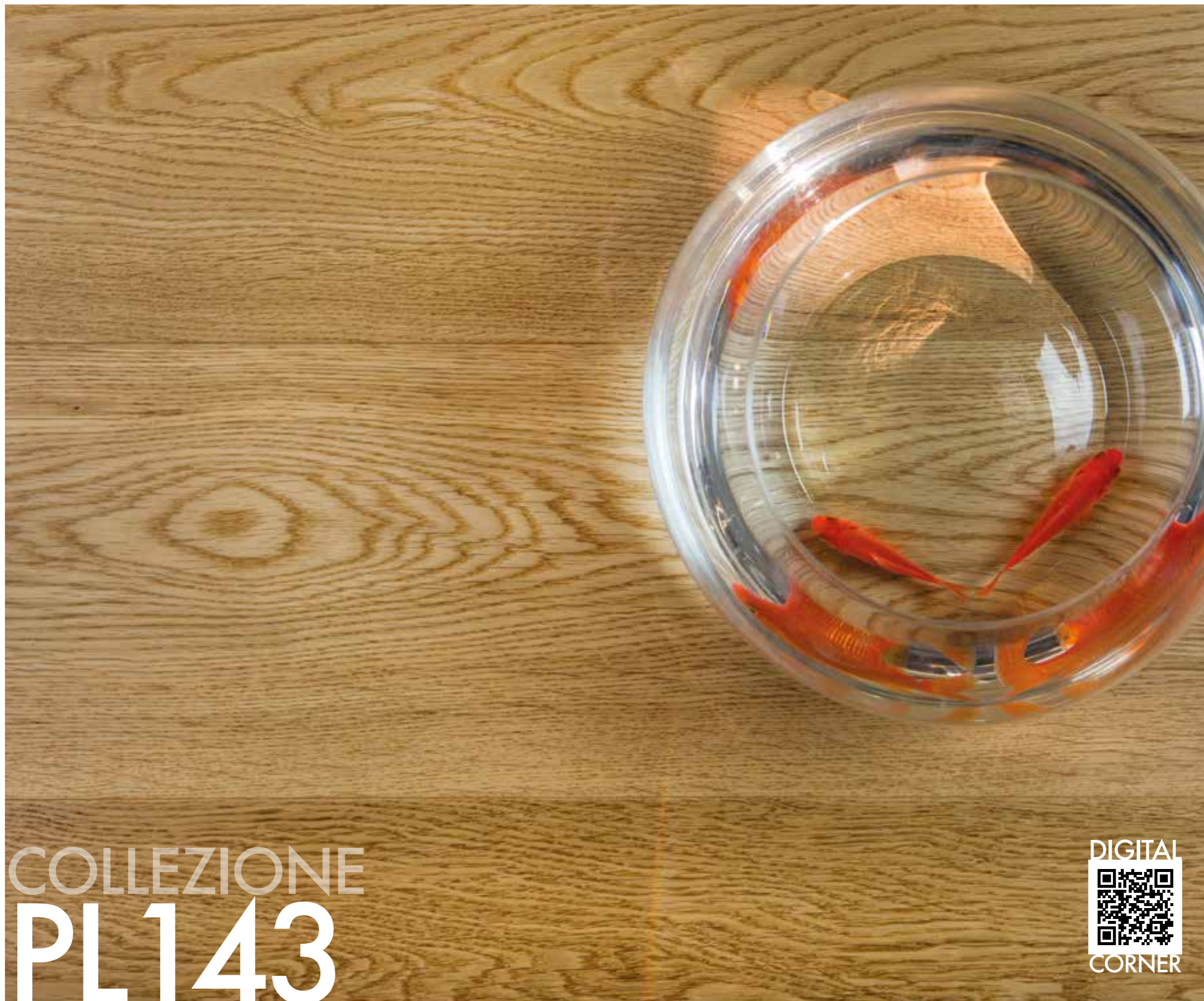

COLLEZIONE  
**PL143**





## COLLEZIONE PL143

Plancia 3 strati in essenza di rovere europeo con varie larghezze e scelte, finitura con vernice UV, scelta rusticone

3-ply oak, brushed and lacquered, available in different choices and widths.

**Essenza / Wood Specie:**

Rovere / Oak

**Supporto / Back Layer:**

Abete + pioppo / Spruce + poplar

**Dimensioni / Dimensions:**

14x150/190/220x1900 mm

**Struttura / Composition:**

Nobile 3 mm + abete/pioppo 9 mm + pioppo 2 mm  
Top layer 3 mm + spruce/poplar 9 mm + poplar 2 mm

**Lavorazione / Surface:**

Leggermente spazzolata / Lightly brushed

**Finitura / Finishing:**

Vernice UV / UV Lacquer

**Bisellatura / Bevel:**

Micro - bisellata / Micro - beveled

**Confezione / Packaging:**

m<sup>2</sup> 150=2,28 / 190=2,166 / 220=2,09

**Riscaldamento a pavimento / Floor heating:**

Adatto / Suitable



PL143 - DE



Tipo di posa / Installation:

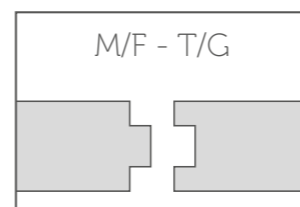

FLOTTANTE / FLOATING  
INCOLLATA / GLUED

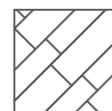

Posabile in 1, 2 e 3 larghezze  
Installable in 1, 2 and 3 widths

Tipologia / Type	Scelta / Grade	Uni / Uni	Dimensioni / Dimensions	Codice / Code	Listino-mq / Price list-m <sup>2</sup>
ROVERE - Spazzolato Oak brushed	ABC	△	14/3x150x1900 mm	PL143A	€ 76,55
ROVERE - Spazzolato Oak brushed	ABC	△	14/3x190x1900 mm	PL143B	€ 81,49
ROVERE - Spazzolato Oak brushed	DE	□	14/3x150x1900 mm	PL143D	€ 66,67
ROVERE - Spazzolato Oak brushed	DE	□	14/3x190x1900 mm	PL143E	€ 74,08
ROVERE - Spazzolato Oak brushed	DE	□	14/3x220x1900 mm	PL143F	€ 81,49
Battiscopa imp.to rovere verniciato naturale 80x13 mm / Oak veneered skirting natural lacquered 80x13 mm					€ / ml 5,44
Accessori disponibili a pag. 189 / Accessories available at page 189					

A sinistra / On the left:  
PL143 - DE

N.B. Per quantità significative verificare disponibilità stock in offerta.





COLLEZIONE  
**PL72**





WHITE

82



TOSCANA



MATERA



NOCCE

83



LIGHT GREY



DARK GREY

NATURALLIZZATO

NATURALE



PL72 - WHITE

## COLLEZIONE PL72

Plancia unica in essenza di rovere, supportata 3 strati, spazzolata verniciata.

3-ply oak plank, brushed and stoned.

**Essenza / Wood Specie:**

Rovere / Oak

**Supporto / Back Layer:**

Abete + pioppo / Spruce + poplar

**Dimensioni / Dimensions:**

14x150x1860 mm

**Struttura / Composition:**

Nobile 3 mm + abete/pioppo 9 mm + pioppo 2 mm

Top layer 3 mm + spruce/poplar 9 mm + poplar 2 mm

**Lavorazione / Surface:**

Leggermente spazzolata / Lightly brushed

**Finitura / Finishing:**

Vernice UV / UV lacquer

**Bisellatura / Bevel:**

Micro - bisellata / Micro - beveled

**Confezione / Packaging:**

2,232 m<sup>2</sup>

**Riscaldamento a pavimento / Floor heating:**

Adatto / Suitable



## PL72 - LIGHT GREY



Tipo di posa / Installation:

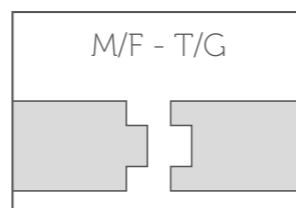

FLOTTANTE / FLOATING  
INCOLLATA / GLUED

A sinistra / On the left:  
PL72 - WHITE

Colore / Colour	Scelta / Grade	Uni / Uni	Dimensioni / Dimensions	Codice / Code	Listino-mq / Price list-m <sup>2</sup>
WHITE	CD	<input type="checkbox"/>	14x150x1860 mm	PL072A	€ 71,61
TOSCANA	CD	<input type="checkbox"/>	14x150x1860 mm	PL072B	€ 71,61
MATERA	CD	<input type="checkbox"/>	14x150x1860 mm	PL072C	€ 71,61
NOCE	CD	<input type="checkbox"/>	14x150x1860 mm	PL072D	€ 71,61
LIGHT GREY	CD	<input type="checkbox"/>	14x150x1860 mm	PL072E	€ 71,61
DARK GREY	CD	<input type="checkbox"/>	14x150x1860 mm	PL072F	€ 71,61
NATURALIZZATO	CD	<input type="checkbox"/>	14x150x1860 mm	PL072G	€ 71,61
NATURALE	CD	<input type="checkbox"/>	14x150x1860 mm	PL072H	€ 71,61
Battiscopa imp.to rovere verniciato in abbinamento 80x13 mm / oak veneered skirting color matching 80x13 mm					€ / ml 9,40
Battiscopa BC imp.to rovere verniciato naturale 80x13 mm / Oak veneered skirting natural 80x13 mm					€ / ml 5,44
Accessori disponibili a pag. 189 / Accessories available at page 189					



COLLEZIONE  
**STONES**





PERLA



ONICE



TOPAZIO



ZAFFIRO

## COLLEZIONE STONES

Plancia unica in essenza di rovere supportata 3 strati, spazzolata verniciata.

3-ply oak plank, brushed and stained.

**Essenza / Wood Specie:**

Rovere / Oak

**Supporto / Back Layer:**

Abete + pioppo / Spruce + poplar

**Dimensioni / Dimensions:**

15x190x1800/1900 mm

**Struttura / Composition:**

Nobile 4 mm + abete/pioppo 9 mm + pioppo 2 mm

Top layer 4 mm + spruce/poplar 9 mm + poplar 2 mm

**Lavorazione / Working:**

Spazzolata / Brushed

**Finitura / Finishing:**

Vernice UV / UV Lacquer

**Bisellatura / Bevel:**

Micro-bisellatura / Micro-beveled

**Confezione / Packaging:**

2,812 m<sup>2</sup>

**Riscaldamento a pavimento / Floor heating:**

Adatto / Suitable



## Stones - ONICE

Tipo di posa / Installation:

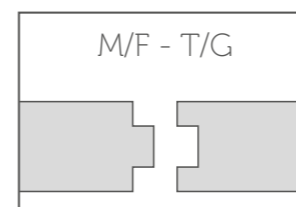

FLOTTANTE / FLOATING  
INCOLLATA / GLUED

Colore / Colour	Scelta / Grade	Uni / Uni	Dimensioni / Dimensions	Codice / Code	Listino-mq / Price list-m <sup>2</sup>
Perla	CD	<input type="checkbox"/>	15x190x1800/1900 mm	PL267/A	€ 81,49
Onice	CD	<input type="checkbox"/>	15x190x1800/1900 mm	PL267/D	€ 81,49
Topazio	CD	<input type="checkbox"/>	15x190x1800/1900 mm	PL267/E	€ 81,49
Zaffiro	CD	<input type="checkbox"/>	15x190x1800/1900 mm	PL267/F	€ 81,49
Battiscopa imp.to rovere verniciato in abbinamento 80x13 mm / oak veneered skirting color matching 80x13 mm					€ / ml 9,40
Accessori disponibili a pag. 189 / Accessories available at page 189					

A sinistra / On the left:  
Stone - TOPAZIO



COLLEZIONE  
**GHOST**





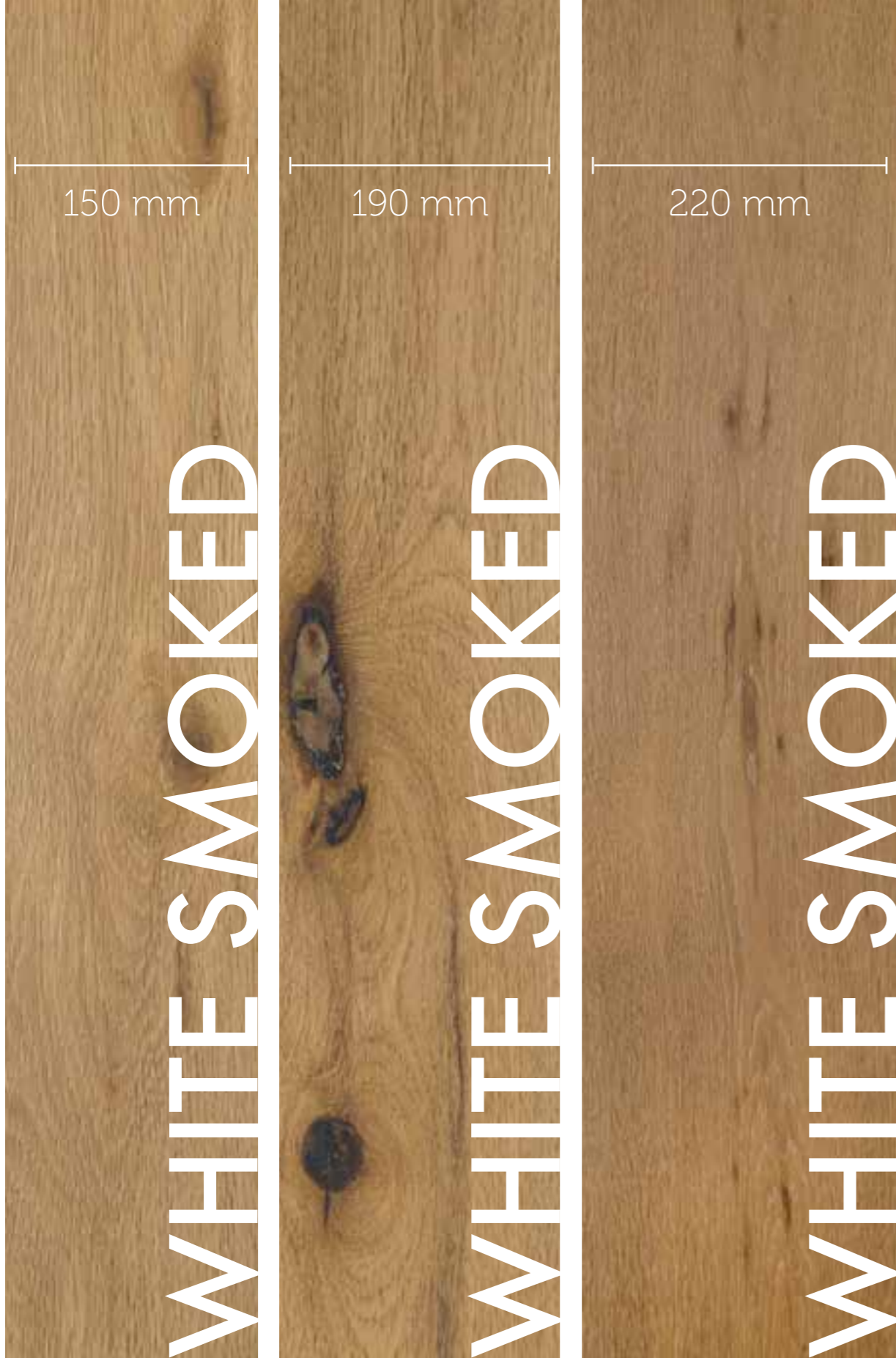

## COLLEZIONE GHOST

Plancia unica in essenza di Rovere, supportata 3 strati, spazzolata verniciata.

3-ply oak brushed and lacquered.

**Essenza / Wood Specie:**

Rovere / Oak

**Supporto / Back Layer:**

Abete + pioppo / Spruce + poplar

**Dimensioni / Dimensions:**

14x150/190/220x1900 mm

**Struttura / Composition:**

Nobile 3 mm + abete 9 mm + pioppo 2 mm

3 mm top layer + 9 mm spruce + 2 mm poplar

**Lavorazione / Surface:**

Spazzolata, smoked / Brushed, smoked

**Finitura / Finishing:**

Vernice UV / UV Lacquered

**Bisellatura / Bevel:**

Micro-Bisellata / Micro-Beveled

**Riscaldamento a pavimento / Floor heating:**

Adatto / Suitable

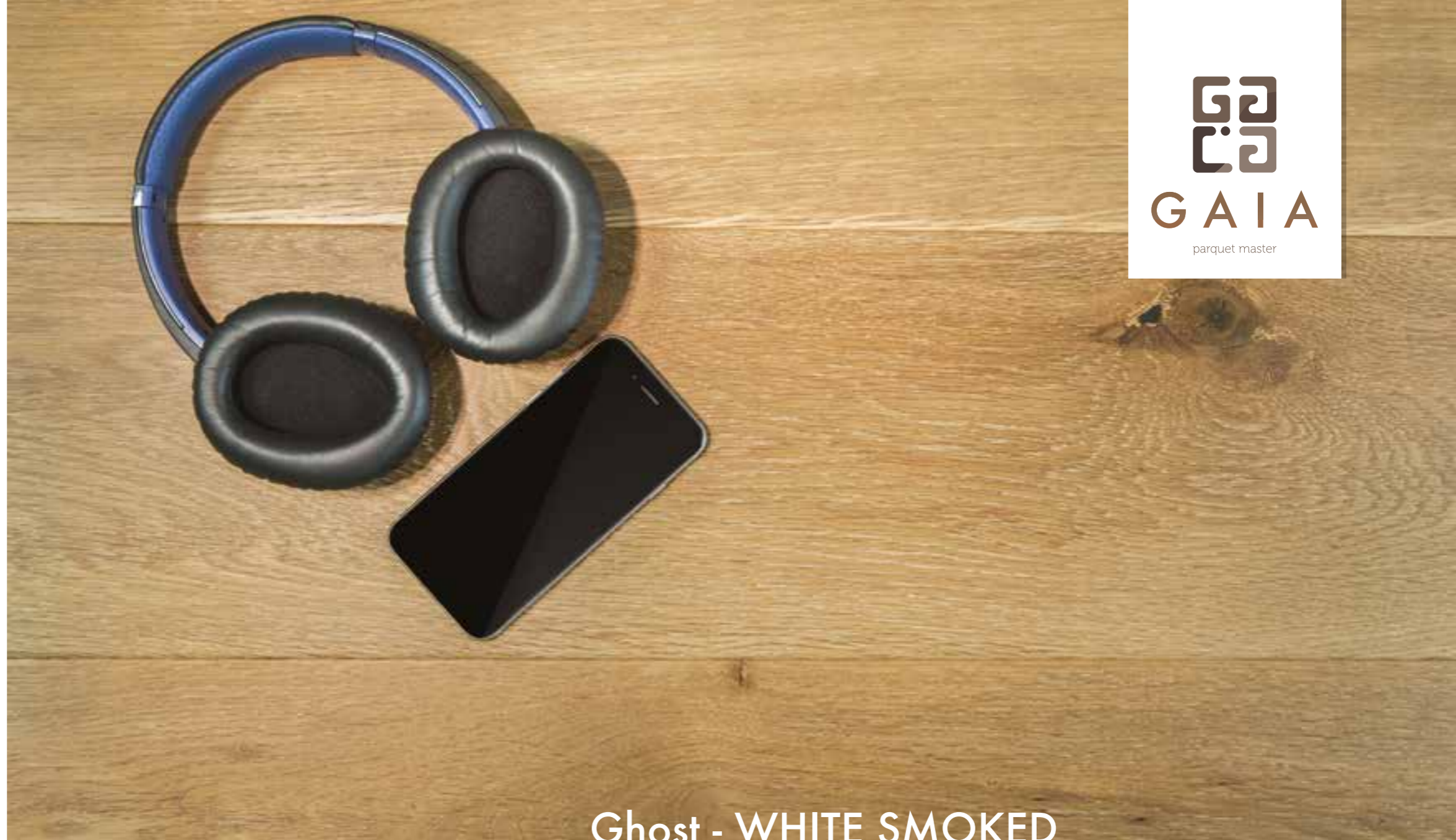

## Ghost - WHITE SMOKED



Tipo di posa / Installation:

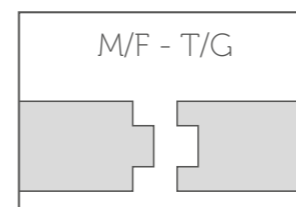

FLOTTANTE / FLOATING  
INCOLLATA / GLUED

Colore / Colour	Scelta / Grade	Uni / Uni	Dimensioni / Dimensions	Codice / Code	Listino-mq / Price list-m <sup>2</sup>
WHITE SMOKED	DE	<input type="checkbox"/>	14x150/190/220x1900 mm	PL197A	€ 71,61
WHITE SMOKED	DE	<input type="checkbox"/>	14x150/190/220x1900 mm	PL197B	€ 79,02
WHITE SMOKED	DE	<input type="checkbox"/>	14x150/190/220x1900 mm	PL197C	€ 86,42
Battiscopa imp.to rovere verniciato in abbinamento 80x13 mm / oak veneered skirting color matching 80x13 mm					€ / ml 9,40
Accessori disponibili a pag. 189 / Accessories available at page 189					

A sinistra / On the left:  
Ghost - WHITE SMOKED



COLLEZIONE  
**MATERIA**



MATERIA ABC

MATERIA CDE



Materia - ABC

## COLLEZIONE MATERIA

Descrizione: Plancia unica in essenza di Rovere, supportata 3 strati, spazzolata verniciata.

3-ply oak brushed and lacquered

**Essenza / Wood Specie:**

ABC: Rovere - DE: Rovere europeo

ABC: Oak - DE: European oak

**Supporto / Back Layer:**

Abete + pioppo / Spruce + poplar

**Dimensioni / Dimensions:**

14x190x1700/1800/1900 mm

**Struttura / Composition:**

Nobile 3 mm + abete/pioppo 9 mm + pioppo 2 mm

Top layer 3 mm + spruce/poplar 9 mm + poplar 2 mm

**Lavorazione / Surface:**

Spazzolata / Brushed

**Finitura / Finishing:**

Vernice UV / UV Lacquered

**Bisellatura / Bevel:**

Micro-Bisellata / Micro-Beveled

**Riscaldamento a pavimento / Floor heating:**

Adatto / Suitable



## Materia - ABC



Tipo di posa / Installation:

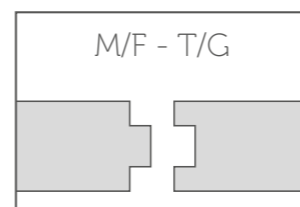

FLOTTANTE / FLOATING  
INCOLLATA / GLUED

A sinistra / On the left:  
Materia

Colore / Colour	Scelta / Grade	Uni / Uni	Dimensioni / Dimensions	Codice / Code	Listino-mq / Price list-m <sup>2</sup>
MATERIA	ABC	△	14x190x1700/1800 mm	PL203	€ 86,42
MATERIA	DE	□	14x190x1900 mm	PL204	€ 79,02
Battiscopa imp.to rovere verniciato in abbinamento 80x13 mm / oak veneered skirting color matching 80x13 mm					€ / ml 9,40
Accessori disponibili a pag. 189 / Accessories available at page 189					



COLLEZIONE  
**VULCANO**



STROMBOLI

ETNA

PANAREA

Vulcano - STROMBOLI

## COLLEZIONE VULCANO

Plancia unica in essenza di rovere francese, supportata  
3 strati, rusticona, piallata.

3-ply french oak, rustic grading, hand scraped.

**Essenza / Wood specie:**

Rovere Francese / French Oak

**Supporto / Back Layer:**

Abete + abete / Spruce + spruce

**Dimensioni / Dimensions:**

14x189x1830 mm

**Struttura / Composition:**

Nobile 3 mm + abete/pioppo 9 mm + pioppo 2 mm

Top layer 3 mm + spruce/poplar 9 mm + poplar 2 mm

**Lavorazione / Surface:**

> Stromboli, Etna:

Smoked forte, piallata, spazzolata

Heavy smoked, hand scraped, brushed

> Panarea:

Piallata, spazzolata / Hand scraped, brushed

**Finitura / Finishing:**

> Stromboli, Etna:

Olio naturale / Natural oil

> Panarea:

olio UV / UV oil

**Bisellatura / Bevel:**

Micro bisello / Micro beveled

**Riscaldamento a pavimento / Floor heating:**

Adatto / Suitable

**Confezione / Packaging:**

2,888 mq/pc



## Vulcano - ETNA

Tipo di posa / Installation:

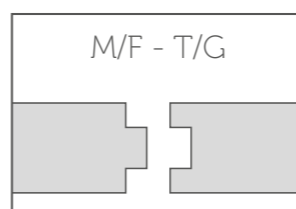

FLOTTANTE / FLOATING  
INCOLLATA / GLUED

Tipologia / Type	Scelta / Grade	Uni / Uni	Dimensioni / Dimensions	Codice / Code	Listino-mq / Price list-m <sup>2</sup>
STROMBOLI	DE	<input type="checkbox"/>	14x189x1830 mm	PL174A	€ 86,42
ETNA	DE	<input type="checkbox"/>	14x189x1830 mm	PL174B	€ 86,42
PANAREA	DE	<input type="checkbox"/>	14x189x1830 mm	PL179	€ 79,02
Battiscopa imp.to rovere oliato in abbinamento 80x13 mm / Oak veneered skirting oiled color matching 80x13 mm					€ / ml 13,60
Accessori disponibili a pag. 189 / Accessories available at page 189					

A sinistra / On the left:  
Vulcano - PANAREA



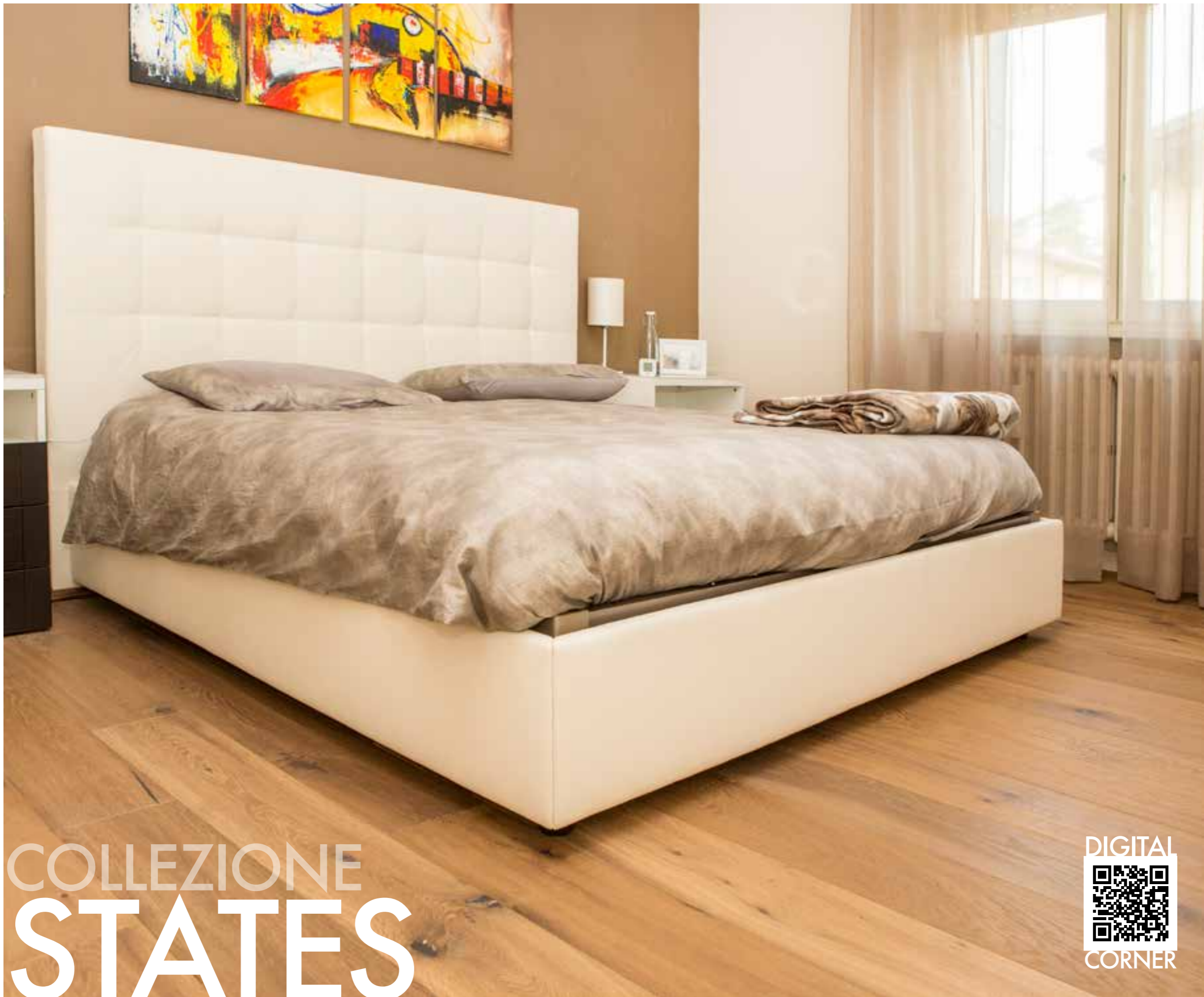

COLLEZIONE  
**STATES**





## COLLEZIONE STATES

Plancia 3 strati in essenza di rovere francese con varie lavorazioni, finitura con olio UV, scelta rusticone.

3-ply french oak with different surfaces, UV oiled, rustic grading.

**Essenza / Wood Specie:**

Rovere francese / French oak

**Supporto / Back Layer:**

Pioppo + betulla / Poplar + birch

**Dimensioni / Dimensions:**

14x190x1900 mm

**Struttura / Composition:**

Nobile 3 mm + pino 9 mm + pioppo 2 mm

Top layer 3 mm + pine 9 mm + poplar 2 mm

**Lavorazione / Working:**

> Arizona, Bahamas, Colorado:

Smoked, piallata e spazzolata / Smoked hand scraped and brushed

> Dakota:

Smoked, segato naturale / Smoked, natural saw mark

**Finitura / Finishing:**

Oliata UV/ UV oiled

**Bisellatura / Bevel:**

4V anticata / 4V antiqued

**Confezione / Packaging:**

2,888 m<sup>2</sup>

**Riscaldamento a pavimento / Floor heating:**

Adatto / Suitable



## States - DAKOTA



Tipo di posa / Installation:

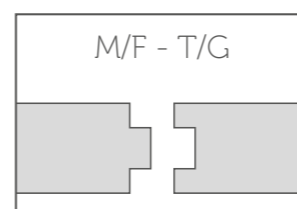

FLOTTANTE / FLOATING  
INCOLLATA / GLUED

Colore / Colour	Scelta / Grade	Uni / Uni	Dimensioni / Dimensions	Codice / Code	Listino-mq / Price list-m <sup>2</sup>
ARIZONA	DE	<input type="checkbox"/>	14/3x190x1900 mm	PL161A	€ 91,36
BAHAMAS	DE	<input type="checkbox"/>	14/3x190x1900 mm	PL161B	€ 91,36
COLORADO	DE	<input type="checkbox"/>	14/3x190x1900 mm	PL161C	€ 91,36
DAKOTA	DE	<input type="checkbox"/>	14/3x190x1900 mm	PL161D	€ 91,36
Battiscopa imp.to rovere oliato in abbinamento 80x13 mm / Oak veneered skirting oiled color matching 80x13 mm					€ / ml 13,60
Accessori disponibili a pag. 189 / Accessories available at page 189					

A sinistra / On the left:  
States - ARIZONA



COLLEZIONE  
**OLIMPIA**



A vertical wood sample with a light, pale greyish-brown color and a subtle, wavy grain pattern. A small, dark blue knot is visible near the top.

ATENA

120

A vertical wood sample with a medium brown color and a prominent, wavy grain pattern. Several dark knots are scattered throughout.

AFRODITE

A vertical wood sample with a medium brown color and a wavy grain pattern. A prominent, dark, vertical crack or inclusion runs through the center.

DIONISIO

A vertical wood sample with a medium brown color and a wavy grain pattern. The texture is relatively smooth with some minor knots.

HERMES

121

A vertical wood sample with a dark greyish-brown color and a wavy grain pattern. The texture is slightly more pronounced than the previous samples.

POSEIDONE

A vertical wood sample with a dark brown color and a wavy grain pattern. The texture is very pronounced with many dark knots and a rich, dark tone.

ZEUS

## COLLEZIONE OLIMPIA

Plancia unica in essenza di Rovere francese, supportata  
2 strati, spazzolata verniciata.

2-ply french oak brushed and lacquered.

**Essenza / Wood Specie:**

Rovere francese / French oak

**Supporto / Back Layer:**

Multistrato / Multiply

**Dimensioni / Dimensions:**

15x190x1900 mm

**Struttura / Composition:**

Nobile 4 mm + multistrato 11 mm

4 mm top layer + 11 mm multiply

**Lavorazione / Working:**

Spazzolata / Brushed

**Finitura / Finishing:**

Vernice UV / UV lacquer

**Bisellatura / Bevel:**

Micro bisello / Micro bevel

**Confezione / Packaging:**

2,166 mq/pc

**Riscaldamento a pavimento / Floor heating:**

Adatto / Suitable



## Olimpia - POSEIDONE

Tipo di posa / Installation:

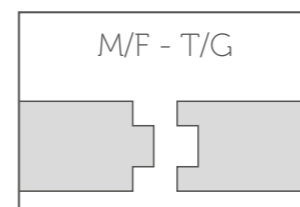

FLOTTANTE / FLOATING

Colore / Colour	Scelta / Grade	Uni / Uni	Dimensioni / Dimensions	Codice / Code	Listino-mq / Price list-m <sup>2</sup>
ATENA	CD	<input type="checkbox"/>	15x190x1900 mm	PL254/A	€ 91,36
AFRODITE	CD	<input type="checkbox"/>	15x190x1900 mm	PL254/B	€ 91,36
DIONISIO	DE	<input type="checkbox"/>	15x190x1900 mm	PL254/C	€ 91,36
HERMES	DE	<input type="checkbox"/>	15x190x1900 mm	PL254/E	€ 91,36
POSEIDONE	CD	<input type="checkbox"/>	15x190x1900 mm	PL254/D	€ 91,36
ZEUS	DE	<input type="checkbox"/>	15x190x1900 mm	PL254/F	€ 91,36
Battiscopa imp.to rovere verniciato in abbinamento 80x13 mm / oak veneered skirting color matching 80x13 mm					€ / ml 9,40
Accessori disponibili a pag. 189 / Accessories available at page 189					

A sinistra / On the left:  
States - AFRODITE



COLLEZIONE  
**BARRIQUE**



## COLLEZIONE BARRIQUE

Plancia unica in essenza di Rovere francese contro bilanciata in essenza, dimensioni grandi, dall'aspetto rustico.

3-ply french oak, with oak counter balance, large dimensions, rustic look.

**Essenza / Wood Specie:**

Rovere francese / French oak

**Supporto / Back Layer:**

Contro bilanciata in Rovere / Oak back layer

**Dimensioni / Dimensions:**

15/4x220x2200 mm

**Struttura / Composition:**

Nobile 4 mm + pino 7 mm + rovere 4 mm  
4 mm top layer + 7 mm poplar + 4 mm oak

**Lavorazione / Working:**

Segato naturale, spazzolato forte e rusticato  
4 mm top layer + 7 mm pine + 4 mm oak

**Finitura / Finishing:**

Vernice UV / UV lacquer

**Bisellatura / Bevel:**

Molto marcata / Heavy bevel

**Riscaldamento a pavimento / Floor heating:**

Adatto / Suitable



## Barrique - PIENZA

Tipo di posa / Installation:

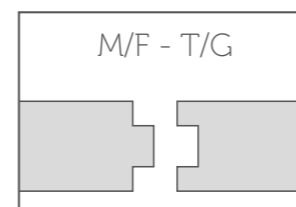

FLOTTANTE / FLOATING  
INCOLLATA / GLUED

Colore / Colour	Scelta / Grade	Uni / Uni	Dimensioni / Dimensions	Codice / Code	Listino-mq / Price list-m <sup>2</sup>
PRELEVIGATO GREZZO	DEF	<input type="checkbox"/>	15x220x2200 mm	PL220G	€ 108,65
PIENZA	DEF	<input type="checkbox"/>	15x220x2200 mm	PL220	€ 113,59
Battiscopa imp.to rovere BC verniciato in abbinamento 80x13 mm / Oak veneered skirting color matching 80x13 mm					€ 13,60
Accessori disponibili a pag. 189 / Accessories available at page 189					

A sinistra / On the left:  
Barrique - PIENZA





COLLEZIONE  
**ALPES**





CHAMONIX



SESTRIERE



LATHUILLE



Alpes - SESTRIERE

## COLLEZIONE ALPES

Plancia unica in essenza di rovere francese, formato extralarge, spazzolata oliata UV.

2-ply french oak, extra large dimensions, brushed and UV oiled.

**Essenza / Wood Specie:**

Rovere francese / French oak

**Supporto / Back Layer:**

Multistrato / Multiply

**Dimensioni / Dimensions:**

14x240x2200 mm

**Struttura / Composition:**

Nobile 4 mm + multistrato 10 mm

4 mm top layer + 10 mm multiply

**Lavorazione / Surface:**

Spazzolata / Brushed

**Finitura / Finishing:**

Olio UV / UV oiled

**Bisellatura / Bevel:**

Micro bisellata / Micro-beveled

**Riscaldamento a pavimento / Floor heating:**

Adatto / Suitable



## Alpes - CHAMONIX



Tipo di posa / Installation:

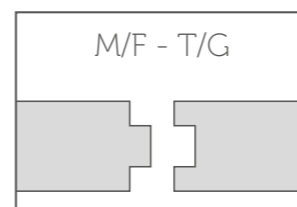

INCOLLATA / GLUED

Colore / Colour	Scelta / Grade	Uni / Uni	Dimensioni / Dimensions	Codice / Code	Listino-mq / Price list-m <sup>2</sup>
CHAMONIX	CDE	<input type="checkbox"/>	14x240x2200 mm	PL162A	€ 113,59
SESTRIERE	CDE	<input type="checkbox"/>	14x240x2200 mm	PL162B	€ 113,59
LA THUILE	CDE	<input type="checkbox"/>	14x240x2200 mm	PL162C	€ 113,59
Battiscopa imp.to rovere oliato in abbinamento 80x13 mm / oak veneered skirting oiled colour matching 80x13 mm					€/ml 13,60
Accessori disponibili a pag. 189 / Accessories available at page 189					

A sinistra / On the left:  
Alpes - LA THUILE



COLLEZIONE  
**COUNTRY**





## COLLEZIONE COUNTRY

Plancia unica in essenza di rovere, supportata 3 strati, spazzolata oliata rusticone.

3-ply oak brushed and oiled, rustic grading.

**Essenza / Wood Specie:**

Rovere / Oak

**Supporto / Back Layer:**

Abete + pioppo / Spruce + poplar

**Dimensioni / Dimensions:**

15x190x600/1860 mm

**Struttura / Composition:**

Nobile 3,5 mm + abete 9 mm + pioppo

2 mm top layer 3,5 mm + spruce 9 mm + poplar 2 mm

**Lavorazione / Surface:**

Spazzolata / Brushed

**Finitura / Finishing:**

Olio ossidativo / Oxidative oil

**Bisellatura / Bevel:**

2V sul lato lungo / 2V on the sides

**Confezione / Packaging:**

2,12 m<sup>2</sup>

**Riscaldamento a pavimento / Floor Heating:**

Adatto / Suitable

**GAIA**  
parquet master



## Country - SMOKED NATURAL



Tipo di posa / Installation:

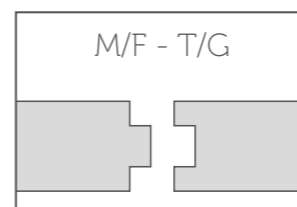

FLOTTANTE / FLOATING  
INCOLLATA / GLUED

Colore / Colour	Scelta / Grade	Uni / Uni	Dimensioni / Dimensions	Codice / Code	Listino-mq / Price list-m <sup>2</sup>
SMOKED NATURAL	DE	<input type="checkbox"/>	15/3,5x190x600/1860 mm	COU264	€ 111,12
SMOKED WHITE	DE	<input type="checkbox"/>	15/3,5x190x600/1860 mm	COU262	€ 111,12
WHITE	DE	<input type="checkbox"/>	15/3,5x190x600/1860 mm	COU099	€ 111,12
Battiscopa imp.to rovere oliato in abbinamento 80x13 mm / Oak veneered skirting oiled color matching 80x13 mm					€ / ml 13,60
Accessori disponibili a pag. 189 / Accessories available at page 189					

A sinistra / On the left:  
Country - WHITE



COLLEZIONE  
**FARM**





Farm - ANTIQUE





OLD CHURCH



TRADITION



PURE



Farm - TRADITION

## COLLEZIONE FARM

Palnacia unica in essenza di rovere, piallata, spazzolata e oliata, rusticone.

3-ply oak, hand scraped, brushed oiled, rustic grading.

**Essenza / Wood Specie:**

Rovere / Oak

**Supporto / Back Layer:**

Abete + pioppo / Spruce + poplar

**Dimensioni / Dimensions:**

15x190x600/1860 mm

**Struttura / Composition:**

Nobile 3,5 mm + abete 9 mm + pioppo 2 mm

Top Layer 3,5 mm + spruce 9 mm + poplar 2 mm

**Lavorazione / Surface:**

Spazzolata, piallata e anticata

Brushed, hand scraped and distressed

**Finitura / Finishing:**

Olio ossidativo / Oxidative oil

**Bisellatura / Bevel:**

4V anticato / 4V distressed

**Confezione / Packaging:**

2,12 m<sup>2</sup>

**Riscaldamento a pavimento / Floor heating:**

Adatto / Suitable



## Farm - HARVEST



Tipo di posa / Installation:

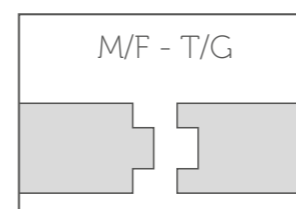

FLOTTANTE / FLOATING  
INCOLLATA / GLUED

Colore / Colour	Scelta / Grade	Uni / Uni	Dimensioni / Dimensions	Codice / Code	Listino-mq / Price list-m <sup>2</sup>
ANTIQUE	DE	<input type="checkbox"/>	15/3,5x190x600/1860 mm	FAR266	€ 118,52
HARVEST	DE	<input type="checkbox"/>	15/3,5x190x600/1860 mm	FAR265	€ 118,52
WHITE	DE	<input type="checkbox"/>	15/3,5x190x600/1860 mm	FAR099	€ 118,52
OLD CHURCH	DE	<input type="checkbox"/>	15/3,5x190x600/1860 mm	FAR938	€ 118,52
TRADITION	DE	<input type="checkbox"/>	15/3,5x190x600/1860 mm	FAR939	€ 118,52
PURE	DE	<input type="checkbox"/>	15/3,5x190x600/1860 mm	FAR284	€ 118,52
Battiscopa imp.to rovere oliato in abbinamento 80x13 mm / Oak veneered skirting oiled color matching 80x13 mm					€ / ml 13,60
Accessori disponibili a pag. 189 / Accessories available at page 189					

A sinistra / On the left:  
Farm - ANTIQUE



**VARIE  
ESSENZE**  
VARIOUS SPECIES

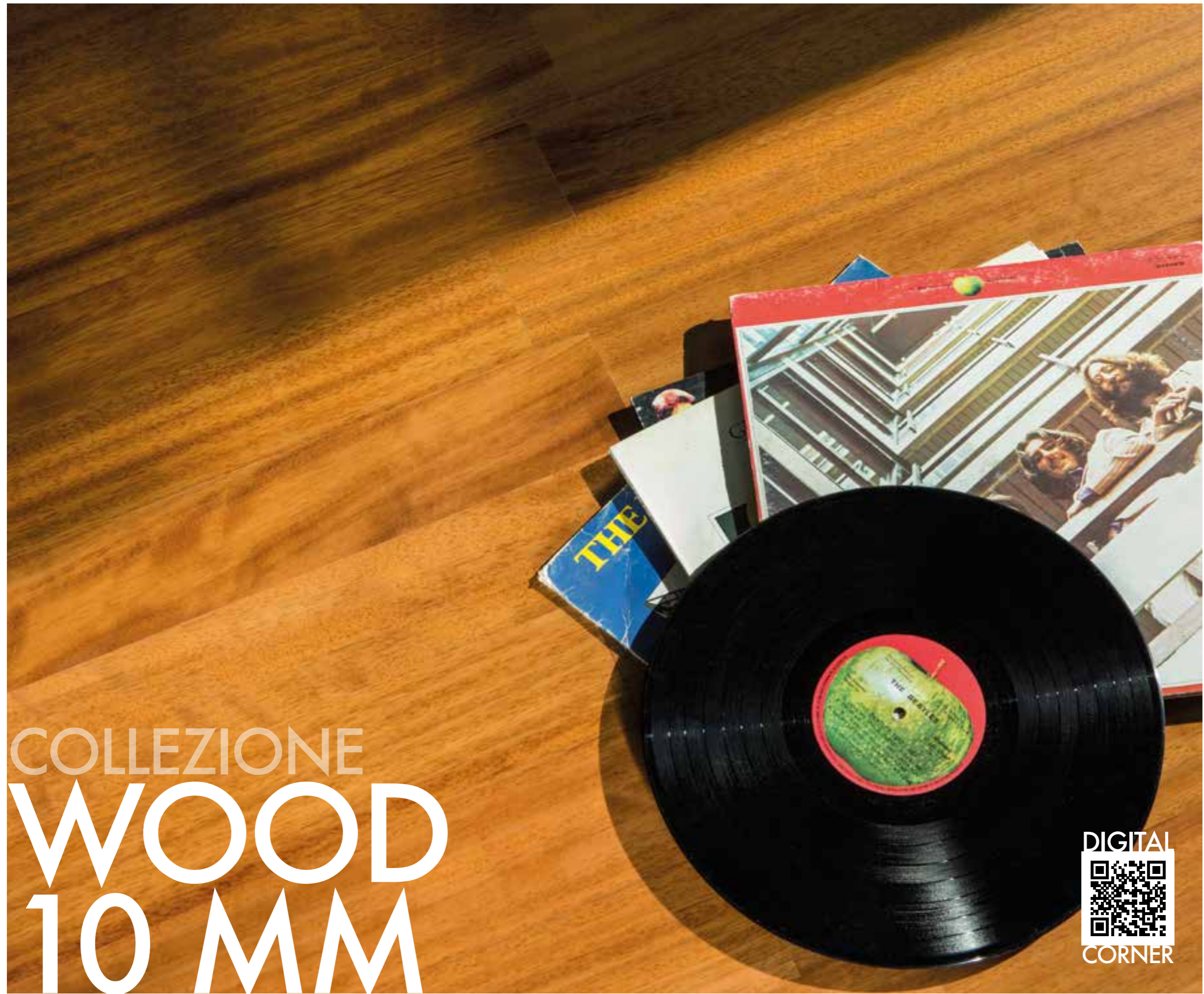

COLLEZIONE  
**WOOD**  
**10 MM**





IROKO

152



DOUSSIÉ



TEAK ASIA

153



NOCE NAZIONALE

## COLLEZIONE WOOD 10 mm

### Essenza / Wood Specie:

Iroko - Doussié - Teak - Noce nazionale

### Dimensioni / Dimensions:

10x90x600/1200 mm

10x120x600/1500 mm

### Struttura / Composition:

Nobile 4 mm + supporto 6 mm

Nobile 3 mm + supporto 7 mm

4 mm top layer + 6 mm back layer

3 mm top layer + 7 mm back layer

### Lavorazione / Surface:

Liscia o spazzolata / Smooth or brushed

### Finitura / Finishing:

Vernice UV / UV lacquer

### Bisellatura / Bevel:

Spigolo vivo – noce nazionale: micro bisellato

Square edge – european walnut: micro beveled

### Riscaldamento a pavimento / Floor heating:

Adatto / Suitable



## Wood 10 mm - DOUSSIÉ

Tipo di posa / Installation:

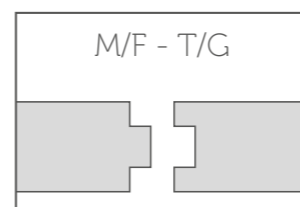

INCOLLATA / GLUED

Essenza / Wood specie	Scelta / Grade	Uni / Uni	Dimensioni / Dimensions	Codice / Code	Listino-mq / Price list-m <sup>2</sup>
IROKO - Verniciato Iroko lacquered	ABC	○	10x90x600/1200 mm	1090I001	€ 74,08
IROKO - Verniciato Iroko lacquered	ABC	○	10x120x600/1500 mm	10120I001	€ 88,90
IROKO - Spazzolato verniciato Iroko brushed and lacquered	ABC	○	10x120x600/1500 mm	10120I002	€ 91,36
DOUSSIÉ - Verniciato Doussié lacquered	ABC	○	10x90x600/1200 mm	1090D001	€ 79,02
DOUSSIÉ - Verniciato liscio Doussié lacquered	ABC	○	10x120x600/1500 mm	10120D001	€ 93,83
DOUSSIÉ - Spazz. verniciato Doussié brushed and lacquered	ABC	○	10x120x600/1500 mm	10120D002	€ 96,30
TEAK ASIA - Verniciato Teak Asia lacquered	ABC	○	10x90x600/1200 mm	1090T001	€ 113,59
TEAK ASIA - Verniciato liscio Teak Asia lacquered	ABC	○	10x120x600/1500 mm	10120T001	€ 123,46
TEAK ASIA - Spazz. verniciato Teak Asia brushed and lacquered	ABC	○	10x120x600/1500 mm	10120T002	€ 128,40
NOCE NAZIONALE European walnut	ABC	○	10x120x600/1500 mm	10120N001	€ 113,59

Accessori disponibili a pag. 189 / Accessories available at page 189

A sinistra / On the left:  
Wood 10 mm - NOCE NAZIONALE



COLLEZIONE  
**BAMBOO**





**NATURALE** ORIZZONTALE

158



**NATURALE** VERTICALE



**EVAPORATO** ORIZZONTALE



**EVAPORATO** VERTICALE

159



**STRAND WOVEN**



## COLLEZIONE BAMBOO

**Essenza / Wood specie:**

Bamboo

**Supporto / Back Layer:**

Massello / Solid wood

**Dimensioni / Dimensions:**

14/15x96x915/960 mm

**Struttura / Composition:**

14/15 mm

**Lavorazione / Surface:**

Vedi tabella / Refer to table

**Finitura / Finishing:**

Vernice UV / UV lacquer

**Bisellatura / Bevel:**

4V

**GAIA**  
parquet master



## Bamboo - STRAND WOVEN



Tipo di posa / Installation:

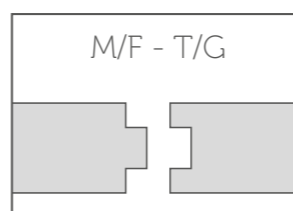

INCOLLATA / GLUED

Tipologia / Type	Lavorazione / Surface	Dimensioni / Dimensions	Codice / Code	Listino-mq / Price list-m <sup>2</sup>
ORIZZONTALE NATURALE Natural horizontal	LISCIO / Smooth	15x96x960 mm	BAM001	€ 59,26
VERTICALE NATURALE Natural vertical	LISCIO / Smooth	15x96x960 mm	BAM002	€ 59,26
ORIZZONTALE EVAPORATO Carbonized horizontal	LISCIO / Smooth	15x96x960 mm	BAM003	€ 59,26
VERTICALE EVAPORATO Carbonized vertical	LISCIO / Smooth	15x96x960 mm	BAM004	€ 59,26
EVAPORATO STRAND WOVEN Carbonized strand woven	LISCIO / Smooth	14x96x915 mm	BAM005	€ 69,14
Battiscopa imp.to bamboo verniciato naturale 80x13 mm / bamboo veneered skirting natural lacquered 80x13 mm				€ / ml. 11,12
Accessori disponibili a pag. 189 / Accessories available at page 189				

A sinistra / On the left:  
Bamboo - NATURALE VERNICIATO VERTICALE



COLLEZIONE  
**LARICE**  
**190**



## COLLEZIONE LARICE 190

**Essenza / Wood specie:**

Larice / Larch

**Supporto / Back Layer:**

Abete + larice / Spruce + larch

**Dimensioni / Dimensions:**

15x190x1900 mm

**Struttura / Composition:**

Nobile 4 mm + Abete 9 mm + Pioppo 2 mm  
Top layer 4mm + spruce 9 mm + poplar 2 mm

**Lavorazione / Surface:**

Vedi tabella / Refer to table

**Finitura / Finishing:**

Grezza - olio UV / Unfinished - UV oil

**Bisellatura / Bevel:**

4V

**Riscaldamento a pavimento / Floor heating:**

Adatto / Suitable



## Larice 190

Tipo di posa / Installation:

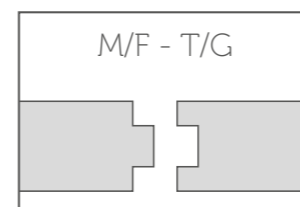

FLOTTANTE / FLOATING  
INCOLLATA / GLUED

Tipologia / Type	Scelta / Grade	Uni / Uni	Dimensioni / Dimensions	Codice / Code	Listino-mq / Price list-m <sup>2</sup>
LARICE Prelevigato grezzo Larch unfinished	ABC	△	15/4x190x1900 mm	PL026E1	€ 74,08
LARICE Spazzolato grezzo Larch brushed unfinished	ABC	△	15/4x190x1900 mm	PL026D1	€ 76,55
LARICE Spazzolato oliato Larch brushed oiled	ABC	△	15/4x190x1900 mm	PL033A	€ 79,02
Battiscopa imp.to larice verniciato naturale 80x13 mm / larch veneered skirting natural lacquered 80x13					€ / ml. 741
Accessori disponibili a pag. 189 / Accessories available at page 189					

A sinistra / On the left:  
Larice 190



COLLEZIONE  
**TEAK**  
**ASIA**



## COLLEZIONE TEAK ASIA

**Essenza / Wood specie:**

Teak Asia / Teak Asia

**Supporto / Back Layer:**

Multistrato betulla / Birch multiply

**Dimensioni / Dimensions:**

14x135x600 / 1800 mm

14x190x600 / 2000 mm

**Struttura / Composition:**

Nobile 3,5 mm + multistrato 10,5 mm

Top layer 3,5 mm + multiply 10,5 mm

**Lavorazione / Surface:**

Vedi tabella / Refer to table

**Finitura / Finishing:**

Vernice UV / UV lacquer

**Bisellatura / Bevel:**

4V

**Riscaldamento a pavimento / Floor heating:**

Adatto / Suitable



## Teak Asia - SPAZZOLATO VERNICIATO

Tipo di posa / Installation:

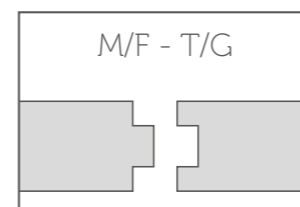

INCOLLATA / GLUED

Tipologia / Type	Scelta / Grade	Uni / Uni	Dimensioni / Dimensions	Codice / Code	Listino-mq / Price list-m <sup>2</sup>
TEAK ASIA Verniciato liscio / Lacquered	AB	○	14/3,5x135x600/1800 mm	TEA135A	€ 158,03
TEAK ASIA Verniciato liscio / Lacquered	AB	○	14/3,5x190x600/2000 mm	TEA190A	€ 167,91
TEAK ASIA Spazz. verniciato / Brushed and lacquered	AB	○	14/3,5x135x600/1800 mm	TEA135B	€ 162,97
TEAK ASIA Spazz. verniciato / Brushed and lacquered	AB	○	14/3,5x190x600/2000 mm	TEA190B	€ 172,84
Battiscopa imp.to teak verniciato naturale 80x13 mm / teak veneered skirting natural lacquered 80x13 mm					€ / ml. 741
Accessori disponibili a pag. 189 / Accessories available at page 189					

COLLEZIONE  
**NOCE  
AMERI-  
CANO**



## COLLEZIONE NOCE AMERICANO

**Essenza / Wood specie:**  
Noce americano / Walnut

**Supporto / Back Layer:**  
Multistrato / Multiply

**Dimensioni / Dimensions:**  
15x190x1900

**Spessore / Thickness:**  
Nobile 4 mm + multistrato 11 mm  
4 mm top layer + 11 mm multiply

**Lavorazione / Surface:**  
Leggermente spazzolato / Slightly brushed

**Finitura / Finishing:**  
Vernice UV / UV lacquer

**Bisellatura / Bevel:**  
Micro bisellata / Micro-beveled

**Riscaldamento a pavimento / Floor heating:**  
Adatto / Suitable



**GAIA**  
parquet master

## Noce Americano

Tipo di posa / Installation:

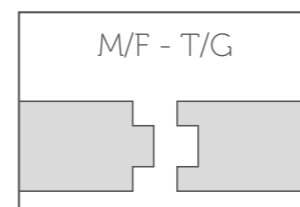

INCOLLATA / GLUED

Tipologia / Type	Scelta / Grade	Uni / Uni	Dimensioni / Dimensions	Codice / Code	Listino-mq / Price List-m2
NOCE AMERICANO	ABCD	□	15/4X190X19000 mm	WAL190A	€ 138,28
Battiscopa imp.to noce americano verniciato naturale 80x13 mm / walnut veneered skirting natural lacquered 80x13 mm					€ / ml 7,91
Accessori disponibili a pag. 189 / Accessories available at page 189					

A sinistra / On the left:  
Noce Americano



WPC  
PAVIMENTI  
PER ESTERNI  
WPC  
OUTDOOR FLOORING







GHIACCIO



GRIGIO



TERRA



MARRONE



TEAK



MATTONI

∨  
NOVITÀ



NOVITÀ  
**WPC  
PROTECTA**



PERLA









NOCE



Doghe double face



## COLLEZIONE WPC / Collection WPC

Descrizione / Description	Dimensioni / Dimensions	Codice / Code	Listino / Price list
 <p><b>WPC pieno 23 mm</b> <b>Solid WPC 23 mm</b></p> <p>Un lato millerighe e un lato spazzolato one side multilines and one side brushed</p>	23x150x2200 mm	Ghiaccio - WPCA001 Grigio - WPCA002 Terra - WPCA003 Marrone - WPCA004 Teak - WPCA005 Mattone - WPCA006	108,65 €/mq
 <p><b>WPC PROTECTA</b></p> <p>Un lato effetto legno ed un lato spazzolato forte double-face One side wood effect and one side heavy brushed double-face</p>	23x140x2200	WPCC009	88,89 €/mq
 <p><b>Magatello WPC / WPC keel</b></p> <p>Posare con interasse 30-35 cm = ml 4 al mq Install with a 30+35 cm centre to centre distance = 4 mt per smq</p>	30x40x2200 mm	WPC101A002	4,45 €/ml
 <p><b>Magatello alluminio</b> <b>Aluminium keel</b></p> <p>Posare con interasse 30-35 cm = ml 4 al mq Install with a 30+35 cm centre to centre distance = 4 mt per smq</p>	25x50x2400 mm 30x40x2400 mm	WPC102 WPC103	9,40 €/ml
 <p><b>Clip inox galvanizzate nere</b> <b>Black galvanized inox clip</b></p> <p>Posare con interasse 30-35 cm = nr. 25 al mq Install with a 30+35 cm centre to centre distance = nr. 25 per sqm</p>	/	WPC112	0,60 €/cad.
 <p><b>Vite per magatello WPC</b> <b>Vite autopercorante per magatello alluminio</b> <b>Screw for WPC keels</b> <b>Auto-piercing for aluminium keels</b></p> <p>Uguale quantità delle clips Same quantity as for the clips</p>	/	WPC105 WPC111	0,10 €/cad.
 <p><b>Starter inox / Inox starter</b></p> <p>Quantità da valutare in base alla partenza Quantity to be evaluated according to the starting</p>	/	WPC106	€ 0,62 €/cad.
 <p><b>Angolare di chiusura in alluminio verniciato in abbinamento</b> <b>Aluminium corner cover with matching color</b></p> <p>Quantità da valutare in base al bordo da ricoprire Quantity to be evaluated according to the lenght of the side to cover</p>	40x40x2500 mm	Ghiaccio - WPC107A001 Grigio - WPC107A002 Terra - WPC107A003 Marrone - WPC107A004 Teak - WPC107A005 Mattone - WPC107A006	€ 11,12 €/ml



Pacchetto completo per wpc pieno (6 colori) Full package for solid WPC (6 colors)	Codice / Code	Listino / Price list
DOGHE WPC + MAGATELLI IN ALLUMINIO + CLIPS + VITI WPC board + aluminium keels + clips + screwers	WPCPAC	€ 161,75



# PAVIMENTO PER ESTERNI COMPOSITO

## Composite outdoor flooring

### Caratteristiche tecniche:

Il Wood Plastic Composite è un materiale composito formato da fibra di bamboo (60%), materiale plastico (polietilene alta densità riciclato grado A-30%) e additivi chimici (10%) che gli conferiscono le caratteristiche tecniche idonee per la posa per esterni.

Rispetto ai prodotti per esterni in legno, con il WPC si eliminano la necessità di manutenzione costante ed assidua e soprattutto le fastidiose e pericolose scheggiature garantendo la possibilità di camminare a piedi nudi.

E' inoltre un'alternativa ecologica, ecocompatibile e riciclabile al 100% perché, rispetto ai normali decking da esterno in legno massello, preserva il taglio forestale.

Il pavimento in oggetto, oltre a quanto detto sopra, possiede altri aspetti positivi quali:

- sopporta escursioni termiche da -40 a +60 gradi centigradi
- antiscivolo, non scheggia
- testato in ambienti marini, resiste ad acqua e sale
- inattaccabile da termiti ed insetti, imputrescibile

### Manutenzione straordinaria:

Essendo composto da fibra di bamboo e polvere di legno, il WPC, pur avendo un grado di assorbimento molto basso, può subire le normali conseguenze in caso di macchiatura con alcuni liquidi. In ogni caso è possibile trattare la pavimentazione con un prodotto specifico denominato "SCUDO WPC" consigliato soprattutto per facilitare la pulizia. Tale prodotto può essere utilizzato per prevenire la formazione di macchie. Pulire accuratamente la superficie con apposito pulitore e, prima della stesura dello "SCUDO WPC", attendere che le doghe siano completamente asciutte.

### Manutenzione ordinaria:

Il WPC va di norma pulito utilizzando acqua e sapone neutro senza l'aggiunta di prodotti particolari. E' inoltre possibile utilizzare candeggina diluita risciacquando abbondantemente dopo l'uso.

### Garanzia:

Il WPC è garantito 15 ANNI da sfilacciamento, spaccature, decadimento ed attacco di insetti; può avere, però, leggere discolorazioni causate dal normale cambiamento dei polimeri e delle fibre che lo compongono.

### Technical features:

Wood plastic Composite is a composite product made of bamboo fiber (60%), plastic materials (high density recycled grade A polyethylene 30%) and chemical additives (10%) which confer the technical qualities ideal for installation in outdoor areas.

Differently from the wooden outdoor flooring, WPC doesn't need any sort of constant or regular maintenance and above all it avoids the annoying and dangerous chippings guaranteeing the possibility to walk on it with bare feet.

Beyond what we have already mentioned, WPC is full of many other favorable qualities:

- It can endure temperature ranges between -40 and +60 degrees
- Anti-slip, it does not chip
- Tested in marine environments, it resists salt and water
- Untouchable by wood-worms and insects, not rottable

### Special maintenance:

WPC is made of bamboo fiber and wood powder so, even if it has a very low absorption grade, it can be subject to the natural consequences when stained by liquids. Anyway it is possible to treat the flooring with a specific product called "SCUDO WPC" recommended above all to facilitate the cleaning. This product can be used to prevent the formations of stains. Clean thoroughly the surface with an appropriate cleaner and wait for the planks to dry completely before applying the SCUDO WPC.

### Ordinary maintenance:

WPC must be cleaned using water and soap and no other specific product. You can also use watered bleach, rinsing it very well at the end.

### Warranty:

WPC is guaranteed 15 years against the fraying and cracking of the wood, the deterioration or attacks from insects; it can, though, be subject to color variations due to the natural changes of the polymers and of the fibres.



WPC PIENO / SOLID WPC:

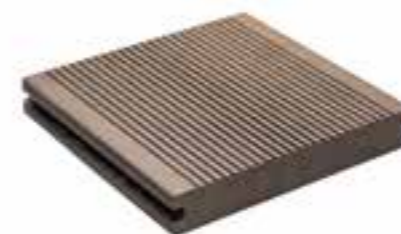

WPC PROTECTA



## PRESCRIZIONI PER LA POSA REGULATION FOR THE INSTALLATION

Il WPC va sempre posato con una pendenza di 10 mm al metro nella direzione longitudinale delle tavole per facilitare lo scolo dell'acqua ed evitarne il ristagno. Il materiale assorbe circa lo 0,3% di acqua e con le variazioni di temperatura si possono avere delle normali dilatazioni e contrazioni delle doghe posate; per questo motivo la posa deve essere effettuata lasciando 15 mm di distanza dalle partenze e almeno 5 mm tra le teste. Questo permetterà alla pavimentazione di "muoversi" naturalmente a seconda dei normali sbalzi di temperatura senza alterare la struttura.

Inoltre bisogna tener conto della temperatura al momento della posa: se la stessa viene effettuata in un periodo caldo (20/25 gradi) potremo ridurre le distanze citate in quanto con la riduzione della temperatura il materiale tenderà a contrarsi e viceversa per permettere questa dilatazione.

La componente plastica, in ambienti e condizioni particolari, può generare campi elettrostatici; questa caratteristica implica che ci si un'adeguata messa a terra e di conseguenza il magatello si consiglia di posarlo fissato alla struttura o sottofondo sottostante. In caso di presenza di guaine isolanti o strutture analoghe verificare sempre la possibilità di forarli senza causare danni.

Si sconsiglia la posa del WPC in ambienti umidi ed al tempo stesso permanentemente all'ombra, e/o scarsamente ventilati. Questo accorgimento vale anche per evitare la formazione di muffe.

Altro aspetto di cui tener conto è l'interasse del magatello che non dovrà mai superare i 35 cm; questo implica un utilizzo di 4 mt di magatello al mq. e nr. 25 clips di fissaggio.

Il WPC non andrà mai posato a colla o fissato alla struttura con viti e/o chiodi e senza camera di ventilazione sottostante.

Altro consiglio utile per l'installatore è quello di utilizzare il meno possibile piccoli ritagli ai bordi della struttura in quanto le clips non bloccano la doga alla struttura sottostante per permettere i piccoli movimenti strutturali; se strettamente necessario, si consiglia l'utilizzo di piccole quantità di colla poliuretanica per evitarne lo scivolamento all'esterno.

Ultimo aspetto molto importante di cui tener conto è che la posa va preferibilmente effettuata "a cassero regolare mezzo/intero", mischiando le tavole prima della posa, così da evidenziare l'effetto legno dovuto a leggere discromie. Si utilizza il doppio magatello all'incontro delle teste delle doghe posandole con sporgenza massima dalla struttura sottostante mai superiore a 5 cm.

WPC must always be installed at an inclination of 10 mm by meter longitudinal to the planks. In order to permit the drainage of the water and to avoid stagnation. The product can absorb the 0,3% of water and it is subject to the changes of temperature which may cause the planks to expand or shrink according to the natural phenomenon; for this reason you must install the product leaving at least 15 mm from the starting point and 5 mm between the heads. This device allows the flooring to move naturally according to the normal temperature changes without changing its structure.

When you are about to install you must always check the temperature of the area: if it is warm (20-25 degrees) the above mentioned distances can be reduced because, when the temperatures will lower, the material will shrink and the same will happen vice versa.

The plastic element can generate electrostatic fields in specific environments and conditions; the existence of this feature is the reason why it is important that there is an adequate grounding system, and therefore we suggest that the keel must be installed fixed to the structure below. Where you have an insulated flooring or a similar structure you must be careful not to make any damage when you drill it.

The flooring should not be installed in damp areas, which are permanently in the shade, or little ventilated. This precaution is valid also to avoid the making of fungus.

Another important feature that must not be forgotten is the centre to centre distance between the two keels; this should never be above 35 cm, this means that you should use 4 mt keels per sqm and 25 fixing clips.

WPC must never be glued or fixed to the surface with screws or nails and not installed where there isn't a ventilation area below.

We also suggest to try not to cut the decking on the sides because it would reduce the grip of the clips that allow the light structural movements; if strictly necessary you could use small quantities of polyurethane glue to avoid them slipping out.

Last but not least, the installation should be done following the bridge deck laying system, mixing the planks before the usage so to highlight the wood effect given by the color differences. The installation must be made using two keels at the meeting of the heads and avoiding to protrude over the under structure for more than 5 cm.



SCHEMA DI POSA WPC / INSTALLATION DIAGRAM

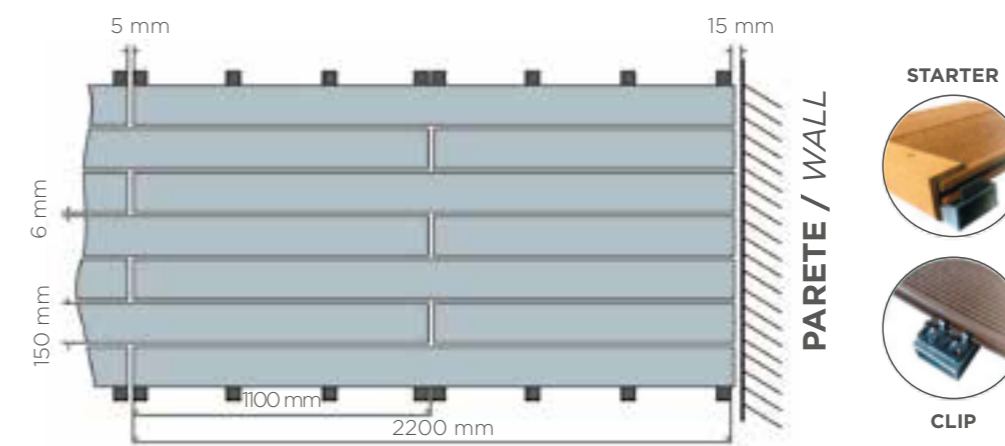

IMPORTANTE:

L'azienda non risponderà di difetti insorti a seguito di una mancata osservanza delle norme sopra citate.

# ACCES- SORI

ACCESSORIES



## BATTISCOPIA SKIRTINGS

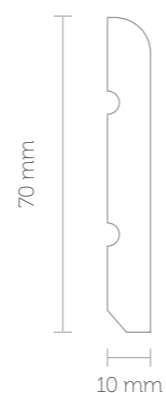

Tipologia / Type	Dimensioni / Dimensions	Codice / Code	Listino-ml / Price list-ml
Imp.to - NOCE TANGANIKI TINTO CHIARO Veneered - Noce tanganika stained light	70x10	BS1070001	€ 4,20
Imp.to - NOCE TANGANIKI TINTO MEDIO Veneered - Noce tanganika stained medium	70x10	BS1070002	€ 4,20
Imp.to - NOCE TANGANIKI TINTO SCURO Veneered - Noce tanganika stained dark	70x10	BS1070003	€ 4,20
Imp.to - LACCATO BIANCO Veneered - Stained white	70x10	BS1070004	€ 4,70

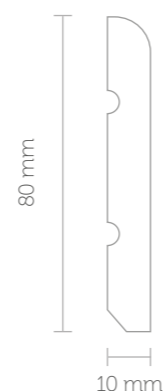

Tipologia / Type	Dimensioni / Dimensions	Codice / Code	Listino-ml / Price list-ml
Imp.to - ROVERE VERNICIATO NATURALE Veneered - Oak lacquered natural	80x10	BS1080001	€ 4,67
Imp.to - IROKO VERNICIATO NATURALE Veneered - Iroko lacquered natural	80x10	BS1080002	€ 5,44
Imp.to - DOUSSIÈ VERNICIATO NATURALE Veneered - Doussiè lacquered natural	80x10	BS1080003	€ 5,44
Imp.to - TEAK VERNICIATO NATURALE Veneered - Teak lacquered natural	80x10	BS1080004	€ 6,92

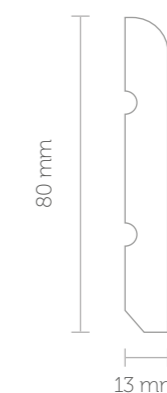

Tipologia / Type	Dimensioni / Dimensions	Codice / Code	Listino-ml / Price list-ml
Imp.to - ROVERE GREZZO Veneered - Oak unfinished	80x13	BS1380001	€ 4,45
Imp.to - ROVERE VERNICIATO NATURALE Veneered - Oak lacquered natural	80x13	BS1380002	€ 5,44
Imp.to - ROVERE VERNICIATO IN ABBINAMENTO Veneered - Matching lacquered oak	80x13	BS1380008	€ 9,40
Imp.to - ROVERE OLIATO IN ABBINAMENTO Veneered - Matching oiled oak	80x13	BS1380009	€ 13,60
Imp.to - IROKO VERNICIATO NATURALE Veneered - Iroko lacquered natural	80x13	BS1380003	€ 5,13
Imp.to - DOUSSIÈ VERNICIATO NATURALE Veneered - Doussiè lacquered natural	80x13	BS1380004	€ 7,17
Imp.to - TEAK VERNICIATO NATURALE Veneered - Teak lacquered natural	80x13	BS1380005	€ 7,41
Imp.to - LARICE VERNICIATO NATURALE Veneered - Larch lacquered natural	80x13	BS1380006	€ 7,41
Imp.to - LACCATO BIANCO Veneered - Stained white	80x13	BS1380007	€ 6,92
Imp.to - NOCE AMERICANO Walnut lacquered natural: veneered	80x13	BS13800010	€ 7,91
Imp.to - NOCE EUROPEO European Walnut lacquered natural	80x13	BS13800011	€ 7,91



## BATTISCOPIA SKIRTINGS

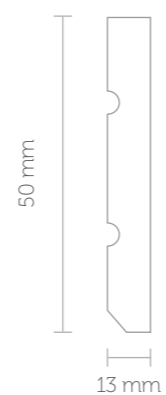

Tipologia / Type	Dimensioni / Dimensions	Codice / Code	Listino-ml / Price list-ml
Imp.to - ROVERE TESTA QUADRA GREZZO Veneered - Unfinished square head oak	50x13	BS1350001	€ 3,71
Imp.to - ROVERE TESTA QUADRA VERNICIATO NATURALE Veneered - Natural lacquered square head oak	50x13	BS1350002	€ 5,44
Imp.to - ROVERE TESTA QUADRA VERNICIATO IN ABBINAMENTO Veneered - Matching lacquered square head oak	50x13	BS1350003	€ 11,12
Imp.to - ROVERE TESTA QUADRA OLIATO IN ABBINAMENTO Veneered - Matching oiled square head oak	50x13	BS1350004	€ 13,60
Imp.to - LACCATO BAINCO TESTA QUADRA veneered stained WHITE	50x13	BS1350005	€ 6,18

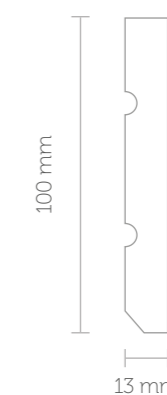

Tipologia / Type	Dimensioni / Dimensions	Codice / Code	Listino-ml / Price list-ml
Imp.to - LACCATO BIANCO Veneered - stained white	100x13	bs10013002	€ 7,65

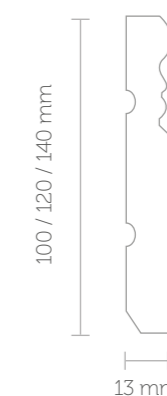

Tipologia / Type	Dimensioni / Dimensions	Codice / Code	Listino-ml / Price list-ml
MASSELLO AYOUS LACCATO BIANCO sagomato Reale Solid ayous stained white Reale design	100x13	BS10013001	€ 10,37
MASSELLO AYOUS LACCATO BIANCO sagomato Reale Solid ayous stained white Reale design	120x13	BS12013001	€ 13,60
MASSELLO AYOUS LACCATO BIANCO sagomato Reale Solid ayous stained white Reale design	140x13	BS14013001	€ 16,05

## TORI STAIR PROFILES



Tipologia / Type	Dimensioni / Dimensions	Codice / Code	Listino-ml / Price list-ml
TORO QUADRO O TONDO in Rovere massello con finitura in abbinamento al parquet / Floor matching square or round solid oak stair profile	1100/1600/2200	TOR001	€ 83,96



Tipologia / Type	Dimensioni / Dimensions	Codice / Code	Listino-ml / Price list-ml
TORO QUADRO in Rovere prefinito con finitura uguale al parquet Floor matching square engineered oak stair profile	/	TOR005	€ 69,13



Tipologia / Type	Dimensioni / Dimensions	Codice / Code	Listino-ml / Price list-ml
ANGOLARE QUADRO in Rovere prefinito con finitura uguale al parquet Floor matching square engineered oak stair profile	/	TOR004	€ 69,13



Tipologia / Type	Dimensioni / Dimensions	Codice / Code	Listino-ml / Price list-ml
TORO QUADRO / ANGOLARE QUADRO in Rovere prefinito con finitura uguale al parquet CON INSERTO IN ACCIAIO ANTISCIVOLO Floor matching square engineered oak stair profile with ANTISLIP steel insert	/	TOR009 TOR010	€ 91,36



## SOGLIE PROFILES



Descrizione / Description	Codice / Code	Listino-cad / Price list - piece
SOGLIA "T" IN ALLUMINIO 14/9 Anodizzata argento Alluminium "T" profile 14/9 anodized silver	S99/TA	€ 14,82
SOGLIA "T" IN ALLUMINIO 14/9 Anodizzata oro Alluminium "T" profile 14/9 anodized gold	S99/TB	€ 14,82
SOGLIA "T" INOX 14/9 / Inox "T" profile 14/9	S99/TC	€ 34,57



Descrizione / Description	Codice / Code	Listino-cad / Price list - piece
SOGLIA DILATAZIONE (oro - argento - bronzo) Tee profile (gold - silver - bronze)	SZ1/A-B-C	€ 24,70



Descrizione / Description	Codice / Code	Listino-cad / Price list - piece
SOGLIA COMPENSAZIONE 7 mm (oro - arg. - bronzo) Reducer profile - 7 mm (gold - silver - bronze)	SC/7SFA-B-C	€ 24,70
SOGLIA COMPENSAZIONE 13 mm (oro - argento) Reducer profile - 13 mm (gold - silver)	SC/13SFA-B	€ 29,63



Descrizione / Description	Codice / Code	Listino-cad / Price list - piece
BASE PER SOGLIA DILATAZ./COMPENS. - 7 mm Tee/Reducer profile base - 7 mm	ST/7	€ 19,76
BASE PER SOGLIA DILATAZ./COMPENS. - 13 mm Tee/Reducer profile base - 13 mm	ST/13	€ 22,23



Descrizione / Description	Codice / Code	Listino-cad / Price list - piece
ANGOLARE PER GRADINO (oro - argento - bronzo) Corner profile (gold - silver - bronze)	SG1A-B-C	€ 29,63



Descrizione / Description	Codice / Code	Listino-cad / Price list - piece
BASE ALLUMINIO PER ANGOLARE GRADINO Corner profile aluminium base	ST/11	€ 19,76

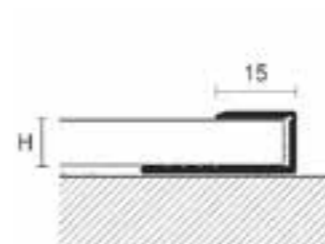

Descrizione / Description	Codice / Code	Listino-cad / Price list - piece
Terminale (oro - argento - bronzo) Terminal profile (gold - silver - bronze)	SRC A-B-C	€ 24,70



Descrizione / Description	Codice / Code	Listino-cad / Price list - piece
SOGLIA BOMBATA ADESIVA ALLUMINIO Alluminium adhesive rounded profile	S020	€ 22,23
SOGLIA BOMBATA ADESIVA OTTONE Brass adhesive rounded profile	S30	€ 27,17

Tutti i modelli sono lunghezza 2700 mm

## PER LA POSA FLOTTANTE FOR FLOATING INSTALLATION



Descrizione Description	Codice Code	Q.tà rotolo / Q.ty per roll	Listino al mq / Price list - per sqm
MATERASSINO IN POLIFRENE sp. 2 mm Polyethylene foam - 2 mm thickness	MAT001	Rot. mq 156 Roll 156 sqm	€ 1,24 Al taglio + € 0,75



Descrizione Description	Codice Code	Q.tà rotolo / Q.ty per roll	Listino al mq / Price list - per sqm
POLYNORM PE MAXIMA per riscaldamento radiante e riduzione del calpestio - sp. 2 mm Maxima foam for floor heating and reduction of the footsteps - 2 mm thickness	MAT002	Rot. mq 12,5 Roll 12,5 sqm	€ 4,45



Descrizione Description	Codice Code	Q.tà rotolo / Q.ty per roll	Listino al mq / Price list - per sqm
MATERASSINO DOUGARD con barriera vapore e bandella adesiva - sp. 2 mm Dougard foam with vapor barrier and adhesive strip - 2 mm thickness	MAT003	Rot. mq 25 Roll 25 sqm	€ 7,41

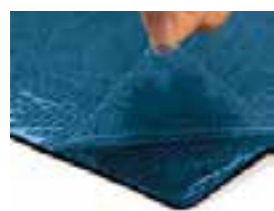

Descrizione Description	Codice Code	Q.tà rotolo / Q.ty per roll	Listino al mq / Price list - per sqm
MATERASSINO INSTALAY IL30hg autoadesivo sp. 3 mm / Instalay foam IL30HG self adhesive 3 mm thickness	MAT004	Rot. mq 15 Roll 15 sqm	€ 18,52

## PER LA POSA INCOLLATA FOR GLUING INSTALLATION



Descrizione Description	Codice / Code	Listino al fusto / Price list - per piece
COLLA EPOSSI - POLIURETANICA BICOMPONENTE Two component epoxy polyurethane solvent	COL001	kg 10 € 49,40

## PRODOTTI PER LA MANUTENZIONE MAINTENANCE PRODUCTS

Descrizione / Description	Al litro / Per liter	Codice / Code	Listino / Price list
CLEANER STAR: detergente battericida neutro multiuso adatto alla pulizia di pavimenti in legno verniciati / Cleaner star: germicide soap multipurpose suitable for the cleaning of lacquered wooden flooring.	Lt 1	MAN001	€ 16,05
POLISH: prodotto nutriente e rigenerante per pavimenti in legno verniciati / Polish: nourishing and reinvigorating product for lacquered wooden flooring.	Lt 1	MAN002	€ 17,30
KIT MANUTENZIONE VERNICIATI: nr. 1 cleaner star + nr. 1 polish + nr. 1 panno microfibra Maintenance kit lacquered.	Pz 1	MAN003	€ 46,92
LIOS SOFT BALM: detergente battericida nutriente per pavimenti in legno oliati per pulizia quotidiana / Lios soft balm: nourishing germicide soap for every cleaning of oiled wooden flooring.	Lt 1	MAN004	€ 27,17
LIOS KRONOS: pulitore intensivo per pavimenti in legno oliati Lios kronos: intensive cleaner for oiled wooden flooring	Lt 1	MAN005	€ 24,70
LIOS TALITA: olio di manutenzione per pavimenti in legno oliati Lios TALITA: maintenance oil for oiled wooden flooring	Lt 1	MAN006	€ 39,52
KIT MANUTENZIONE OLIATI: nr.1 Soft balm + nr. 1 kronos + nr. 1 panno microfibra MAINTENANCE KIT OILED	Pz 1	MAN007	€ 69,14
METAL LACK: cera lucida ad elevata resistenza per pavimenti in legno verniciati soggetti ad elevato calpestio / METAL LACK: high resistance shiny wax for lacquered wooden flooring subject to high traffic	Lt 1	MAN008	€ 29,63
METAL MAT: cera opaca ad elevata resistenza per pavimenti in legno verniciati soggetti ad elevato calpestio / METALMAT: high resistance mat wax for lacquered wooden flooring subject to high traffic	Lt 1	MAN009	€ 38,28
WAX CARE: dispersione di cere idrorepellenti per la manutenzione intensiva di pavimenti in legno verniciati, oliati o cerati / WPC care	Conf. 0,5 lt 0,5 tin	MAN012	€ 17,84
SCUDO WPC trattamento protettivo all'acqua idro - oliorepellente Scudo WPC protective treatment water and oil repellent based on water	Fusto 5 lt resa per 10 mq 5 lt drum, 1 lt per sqm	WPC108	€ 209,88
PULITORE INTENSIVO detergente per WPC / Intensive cleaner for WPC	Conf. 1 lt 1 lt tin	WPC109	€ 24,70 cad.
WPC SPRAY CLEAN: smacchiatore per WPC / WPC spray clean	Conf. 200 ml 200 ml tin	WPC110	€ 27,16

NON  
IMMAGINARE,  
GUARDA.  
DO NOT  
IMMAGINE,  
LOOK.



Prova il nostro planner

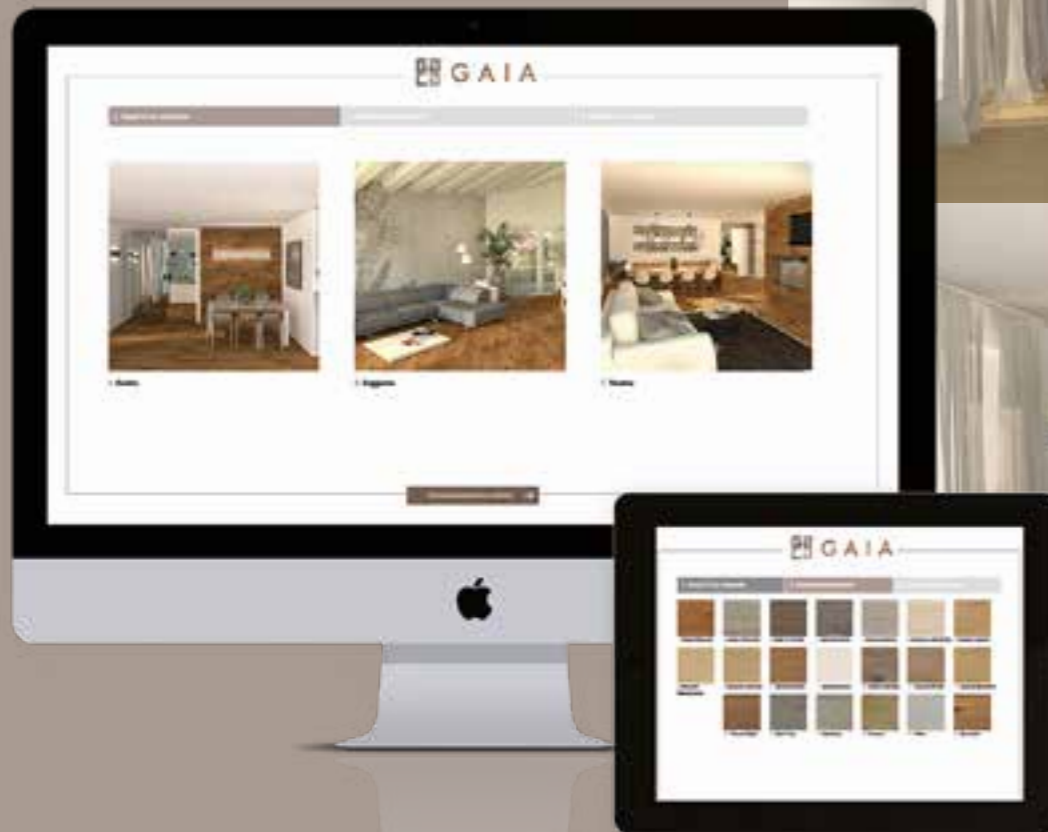

Oggi la tecnologia ci permette di svolgere attività un tempo inimmaginabili. La BGP Trading è molto avanzata in questo settore e dà concretezza alle nuove possibilità, attraverso uno strumento eccezionale, che consente agli utenti di interagire con i prodotti del catalogo. Semplicemente accedendo alla sezione Planner del nostro sito, è possibile sperimentare le diverse tipologie di legno, applicandole, in totale autonomia, agli ambienti proposti. Una volta confrontati visivamente i materiali e i colori, inserendo una metratura indicativa, si può richiedere un preventivo. È anche possibile stampare, salvare o inviare la fotografia ottenuta, tutto con un semplice click.

Avresti mai pensato di poter osservare in anticipo il risultato di una scelta? Grazie al nostro Planner ora puoi. Visita il nostro sito e valuta con i tuoi occhi che aspetto avrà la tua casa, per scegliere veramente la soluzione su misura per te.

Today technology allows us to carry out activities once unimaginable. BGP Trading is very advanced in this sector and gives concreteness to new possibilities, through an exceptional appliance, which allows users to interact with products in the catalogue. Simply entering the section Planner on our site, it is possible to experiment with the different types of wood, applying them, totally autonomously, to the surroundings suggested. Once confronted with the materials and colours visually, inserting indicative measurements, you can request a quotation. It is also possible to print. Save or send the photographs obtained, all with a simple click.

Have you ever thought you would be able to observe in advance the result of a choice? Thanks to our Planner now you can. Visit our site and evaluate with your own eyes what your home will look like, to choose the solution really made to measure for you.



la vera anima del  
**LEGGNO**

Tratto da: **Norma UNI EN 13489 (Elementi multistrato con incastro)**

CARATTERISTICHE	ROVERE (Quercus spp.) FACCIA DELL'ELEMENTO CLASSE		
	●	▲	■
	Alburno sano	Non consentito	Consentito fino al 50% della faccia anteriore, se distribuito
Nodi * sani e aderenti	Consentiti se: diametro ≤ 3 mm	Consentiti se: diametro ≤ 8 mm	
Nodi marci	Consentiti se: diametro ≤ 1 mm se non raggruppati *	Consentiti se: diametro ≤ 2 mm	
Cretti (setolature)	Non consentiti	Consentiti fino a 20 mm di lunghezza per lista	
Inclusioni di corteccia	Non consentite	Non consentite	
Colpo di fulmine	Non consentito	Non consentito	
Deviazione della fibratura	Consentita, nessun limite	Consentita, nessun limite	
Variazione di colore	Consentita leggera variazione	Consentita	
Raggi parenchimatici (specchiature)	Consentiti	Consentiti	
Alterazione biologica	Non consentita	Non consentita	Non consentita, ad eccezione dell'azzurramento e dei fori neri da insetti (moschettatura)

Tutte le caratteristiche sono consentite senza limiti di dimensioni o quantità se non compromettono la resistenza o la qualità di resistenza all'usura delle pavimentazioni di parquet.

- A. Le spaccature nei nodi e i fori causati dai nodi devono essere stuccati.
- B. I nodi si considerano raggruppati se la distanza che li separa, misurata da bordo a bordo, non è maggiore di 30 mm.

CARATTERISTICHE	ALTRI LEGNI DI LATIFOGLIE FACCIA DELL'ELEMENTO CLASSE			
	●	▲	■	
	Alburno sano o cuore A	Non consentito Non consentito	Consentito Consentito fino al 50% della faccia anteriore, se distribuito	Consentite tracce leggere Consentito
Nodi * sani e aderenti	Consentiti se: diametro ≤ 2 mm se non raggruppati C	Consentiti se: diametro ≤ 5 mm se non raggruppati C	Tutte le caratteristiche sono consentite senza limiti di dimensioni o quantità se non compromettono la resistenza o la qualità di resistenza all'usura delle pavimentazioni di parquet	
Nodi marci	Consentiti se: diametro ≤ 1 mm se non raggruppati C	Consentiti se: diametro ≤ 2 mm se non raggruppati C		
Cretti (setolature)	Non consentiti	Non passanti. Consentiti se la larghezza ≤ 0,5% della larghezza dell'elemento		
Inclusioni di corteccia	Non consentite	Non consentite		
Colpo di fulmine	Non consentito	Non consentito		
Deviazione della fibratura	Consentita, nessun limite	Consentita, nessun limite		
Variazione di colore	Consentita. Consentite leggere tracce di scolorimento naturale (linee minerali)	Consentita		
Raggi parenchimatici (specchiature)	Consentiti	Consentiti		
Alterazione biologica	Non consentita	Non consentita		Non consentita, ad eccezione dell'azzurramento e dei fori neri da insetti (moschettatura)

Tutte le caratteristiche sono consentite senza limiti di dimensioni o quantità se non compromettono la resistenza o la qualità di resistenza all'usura delle pavimentazioni di parquet.

- A. L'alburno sano o il "cuore" devono essere scelti secondo la specie di legno interessata.
- B. Le spaccature nei nodi e i fori causati dai nodi devono essere stuccati.
- C. I nodi si considerano raggruppati se la distanza che li separa, misurata da bordo a bordo, non è maggiore di 30 mm.

a) **Ordini:** gli ordini passati a mezzo agente sono subordinati all'accettazione della BGP Trading S.r.l.

b) **Qualità:** i colori e le tonalità dei campioni devono intendersi solo come indicativi per cui la corrispondenza ad essi della merce venduta è sufficiente sia approssimativa, così come l'uniformità del colore deve essere considerata come relativa: viene comunque garantita la fornitura corrispondente alla scelta fatta. Nelle specie legnose Merbau, Doussié, Wengé e Panga Panga possono manifestarsi talvolta tracce di concrezioni di silicio il cui colore va da biancastro al giallo limone che non possono in alcun modo essere considerati difetti o vizi.

c) **Campionatura:** I campioni sono sempre puramente indicativi e mai impegnativi in quanto possono variare a seconda delle partite nella venatura e nel colore.

d) **Dimensioni:** le dimensioni in pianta degli elementi, anche se specificate saranno da intendersi indicative.

e) **Termini:** le date di consegna merce, convenute contrattualmente si intendono indicative talché la società fornitrice non incorrerà in alcun inadempimento se dovessero essere posticipate, per irregolari rifornimenti delle materie prime, per esigenze di organizzazione interna e/o di cantiere, nonché per ogni altra causa di forza maggiore. Tali eventi in nessun caso daranno luogo a risoluzione anche parziale del contratto o diritto a pretese di natura risarcitoria.

f) **Vizi:** la verifica della merce andrà fatta perentoriamente al momento della consegna della stessa; eventuali vizi non evidenti al momento della consegna potranno essere segnalati, presso la nostra Sede legale con raccomandata A/R non oltre 8 giorni dal tempo della consegna, a pena di decadenza. Ad ogni modo, gli obblighi della BGP Trading S.r.l. non andranno oltre il ritiro e la sostituzione della merce difettosa.

g) **Responsabilità:** L'utilizzazione o l'alienazione della merce da parte del cliente acquirente costituiscono pieno riconoscimento della corrispondenza di esso a quanto pattuito e della sua idoneità all'uso cui è destinato.

h) **Modalità di pagamento:** i pagamenti andranno effettuati presso la sede della intestata società fornitrice secondo tempi e modi convenuti nel presente contratto; in caso di pagamento rateale la vendita si intende perfezionata con riserva di proprietà della merce sin al completo pagamento del prezzo complessivo dovuto ai sensi dell'art. 1523 e.e.; eventuali reclami o contestazioni non danno diritto all'acquirente di sospendere o ritardare nei pagamenti convenuti.

i) **Insolvenza:** le irregolarità nei pagamenti autorizzano la BGPT Trading S.r.l. a troncamento ex tempore le forniture oggetto di accordo; gli interessi di mora saranno quelli bancari correnti.

l) **Prezzi:** tutti i prezzi si intendono al metro quadrato se non diversamente specificato e IVA esclusa; qualora, prima della consegna, si verificino incrementi dei costi (di materie prime, trasporti, manodopera, dazi doganali, cambi valutari) il venditore potrà unilateralmente adeguare il prezzo nella misura corrispondente ai de i aumenti, salva la facoltà dell'acquirente di recedere dal contratto quando il prezzo risultasse più alto del 10% di quanto stabilito originariamente, con Sua rinuncia a qualsiasi pretesa di risarcimento nei confronti della BGPT Trading S.r.l.

m) **Garanzia:** qualora la contestazione per vizi o difetti sia ritenuta valida e giustificata, l'acquirente ha diritto alla sostituzione dello stesso, che verrà accettato in reso solo in condizioni originali integre e complete.

n) **Scheda prodotti:** tutti i prodotti vengono accompagnati da una scheda identificativa predisposta dal fornitore, consegnata al cliente e, da quest'ultimo resa disponibile a potenziale acquirente/consumatore. La scheda deve accompagnare il prodotto, qualunque sia la modalità di offerta del prodotto stesso adottata dal cliente nei confronti dell'acquirente/consumatore. Pertanto, è onere del cliente fornire all' acquirente/consumatore detta scheda al momento della conclusione del contratto di vendita ovvero non oltre la consegna dei prodotti (o posa in opera degli stessi). Il cliente terrà indenne e manlevato il fornitore per ogni conseguenza derivante dalla violazione degli obblighi sopra previsti.

o) **Resi:** non si accettano resi salvo accordi particolari con la BGP Trading S.r.l.

p) **Imballaggi:** il loro prezzo, se non diversamente pattuito, si intende compreso a quello della merce; lo smaltimento degli imballaggi e degli scarti di lavorazione sono a carico del cliente.

q) **Foro:** per le parti del presente contratto il Foro esclusivamente competente a dirimere eventuali controversie in ordine all'interpretazione e/o esecuzione dello stesso è quello di Bergamo.

# CONTRACTUAL TERMS

**a) Orders:** orders that are received by BGPTRADING SRL through agents are subject to the firm's approval

**b) Quality:** colors and tones are to be considered as approximate, therefore it is not necessary that they correspond completely to the sold goods, also the uniformity of the color is relative: we however guarantee the supply of what you choose. Merbau, Doussie, Wenge and Panga Panga can sometimes have traces of silicon of lemon yellow or whitish color, which can not be considered as defects.

**c) Samples:** the samples are always just descriptive and never obliging because their color and grain can change according to the different lots

**d) Dimensions:** the dimensions are approximate

**e) Terms:** the delivery dates, defined in the contract, must be considered approximate. The firm therefore will not be thought unfulfilling if these shall be postponed because of irregular supplies of raw material, because of the needs of internal organization or of the construction site or because of unavoidable causes. These reasons shall never be excuse for the annulment of the contract or compensation requests.

**f) Defects:** you must check the material at the moment of the delivery; whatever defects discovered after the delivery must be communicated to us through registered mail within 8 days from the delivery. Anyway BGP TRADING's duties will be no other than to collect the material and to the replacement of the faulty material.

**g) Responsibilities:** when the client uses or transfers the material he acknowledges that it is what he ordered and that it is adequate to its scope.

**h) Payment:** payments must be made to BGP TRADING SRL according to times and ways established in the present contract; in the event that the payment is by installments the property of the material is withhold until the payment of the hole owed price; possible claims are not an excuse for suspending or delaying the payments.

**i) Insolvency:** the irregularity of the payments give BGP TRADING SRL the permission to annul all supplies earlier established; the default interest will be calculated according to the bank's present one.

**l) Prices:** all prices are by square meter if not differently mentioned and VAT excluded; whenever, before the delivery of the products, some costs will increase (raw material, transport, handwork duty fees, exchange rate) the seller is free to adjust the prices according to these rises, the buyer is free to back out of the contract when these increases are higher than the 10% of what originally decided, quitting however any right to ask refund from BGP TRADING SRL.

**m) Warranty:** whenever the claims for faults or defects are true and legitimate the buyer has the right to ask for the exchange of the material, which will be accepted only whether it is still in its original conditions, intact and complete.

**n) Product data sheet:** all the products are followed by their identification data sheet (product data sheet) written by the supplier, delivered to the client who will make it available to the potential buyer/consumer. The sheet has to follow the product, no mind how the client offers this product to the buyer/consumer. Therefore, it is full responsibility of the Client to deliver to the buyer/consumer this sheet when the sale contract is signed and not after the delivery (or installation) of the products. The Client undertakes to indemnify and hold harmless the Supplier against all consequences from the violation of the previously mentioned obligations.

**o) Goods return:** we do not accept the returning of goods unless there is an understanding with BGP TRADING SRL.

**p) Packaging:** the cost of the packaging, if not differently expressed, must be considered included in the price of the products, the disposal of the packaging or of the waste products is complete responsibility of the buyer.

**q) Court:** the only court in charge of settling any claims between the parties regarding the understanding or the execution of the contract is the one of Bergamo.







**Informazioni e preventivi:**

[info@bgptrading.com](mailto:info@bgptrading.com)

T. 0346/25200

**Ordini zona 1 Italia:**

[commerciale@bgptrading.com](mailto:commerciale@bgptrading.com)

T. 0346/25200 int. 1

**Ordini zona 2 Italia:**

[commerciale2@bgptrading.com](mailto:commerciale2@bgptrading.com)

T. 0346/25200 int. 2

**Fatturazione:**

[contabilita@bgptrading.com](mailto:contabilita@bgptrading.com)

T. 0346/25200 int. 3

**Pagamenti:**

[amministrazione@bgptrading.com](mailto:amministrazione@bgptrading.com)

T. 0346/25200 int. 3

